

# Service Manual

AV Control Stereo Receiver

Receiver

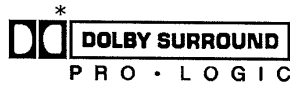

SA-EX120

Colour

(K) . . . . . Black Type

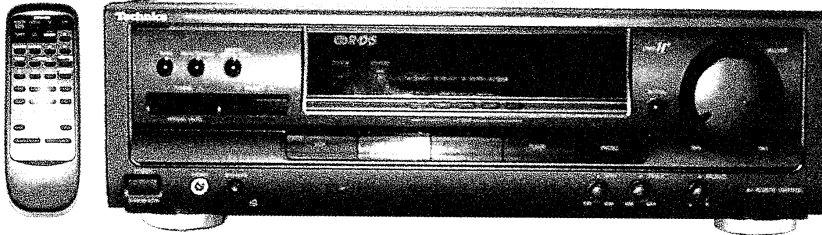

Area

Suffix for Model No.	Area	Colour
(E)	Europe	(K)
(EB)	Great Britain	
(EG)	Germany & Italy	

## Specifications

### Amplifier Section

Power output (at 240V)	
DIN 1 kHz (T.H.D. 1%)	2 x 100 W (4 Ω)
40 Hz-20 kHz continuous power output both channels driven	2 x 80 W (8 Ω)
Total harmonic distortion	
rated power at 40 Hz-20 kHz	0.5% (8 Ω)
half power at 1 kHz	0.07% (8 Ω)
Frequency response	
PHONO	RIAA standard curve (30 Hz-15 kHz) ±0.8 dB
CD, TAPE MONITOR, VCR	10 Hz-40 kHz, ±3 dB
Input sensitivity and impedance	
PHONO	3mV/47 kΩ
CD, TAPE MONITOR, VCR	200 mV/22 kΩ
S/N at rated power (8 Ω)	
PHONO	70 dB (IHF, A: 80 dB)
CD, TAPE MONITOR, VCR	75 dB (IHF, A: 85 dB)
Tone controls	
BASS	50 Hz, +10 to -10 dB
TREBLE	20 kHz, +10 to -10 dB
Output voltage	
TAPE REC (OUT), VCR OUT	200 mV
Channel balance (250 Hz-6.3 kHz)	±1 dB
Channel separation	55 dB
Headphones output level and impedance	430 mV/ 330 Ω

### FM TUNER Section

Frequency range	87.50 - 108.00 MHz
Sensitivity	
S/N 30 dB	1.5 μV/75 Ω
S/N 26dB	1.3 μV/75 Ω
S/N 20 dB	1.2 μV/75 Ω
IHF usable sensitivity	1.5 μV/75 Ω (IHF '58)
IHF 46 dB stereo quieting sensitivity	22 μV/75 Ω

### Total harmonic distortion

MONO	0.2%
STEREO	0.3%
S/N	
MONO	60 dB (73 dB, IHF)
STEREO	58 dB (67 dB, IHF)
Frequency response 20 Hz-15 kHz	+1 dB, -2 dB
Alternate channel selectivity	
±400 kHz	65 dB
Capture ratio	1.5 dB
Image rejection at 98 MHz	40 dB
IF rejection at 98 MHz	70 dB
Spurious response rejection at 98 MHz	70 dB
AM suppression	50 dB
Stereo separation	
1 kHz	40 dB
Carrier leak	
19kHz	-30 dB (-35 dB, IHF)
38 kHz	-50 dB (-55 dB, IHF)
Channel balance (250 Hz-6.3 kHz)	±1.5 dB
Limiting point	1.2 μV
Bandwidth	
IF amplifier	180 kHz
FM demodulator	1000 kHz
Antenna terminal	75 Ω (unbalanced)

### AM TUNER Section

Frequency range	522-1611 kHz
Sensitivity	20 μV, 330 μV/m
Selectivity	
(at 999 kHz)	55 dB
IF rejection	
(at 999 kHz)	50 dB

\* Manufactured under license from Dolby Laboratories Licensing Corporation. DOLBY, the double-D symbol and "PRO LOGIC" are trademarks of Dolby Laboratories Licensing Corporation.

# Technics®

© 1998 Matsushita Electronics (S) Pte. Ltd.  
All rights reserved. Unauthorized copying  
and distribution is a violation of law.

**⚠ WARNING**

This service information is designed for experienced repair technicians only and is not designed for use by the general public. It does not contain warnings or cautions to advise non-technical individuals of potential dangers in attempting to service a product. Products powered by electricity should be serviced or repaired only by experienced professional technicians. Any attempt to service or repair the product or products dealt with in this service information by anyone else could result in serious injury or death.

**■ General****Power supply [E,EG]**

AC; 230, 50Hz

**[EB]**

AC; 230~240 V, 50Hz

**Power Consumption**

190 W

**Dimensions**

430 (W) x 136 (H) x 309 (D) mm

**Weight**

7.0 kg

**Notes :**

1. Specifications are subject to change without notice. Weight and dimensions are approximate.
2. Total harmonic distortion is measured by the digital spectrum analyzer.

**■ Contents**

	PAGE		PAGE
• BEFORE REPAIR AND ADJUSTMENT .....	2	• BLOCK DIAGRAM .....	18 ~ 20
• PROTECTION CIRCUITRY .....	2	• TERMINAL FUNCTION OF ICs .....	21
• CAUTION FOR AC MAINS LEAD .....	3	• TERMINAL GUIDE OF ICs, TRANSISTORS & DIODES .....	22
• ACCESSORIES .....	4	• SCHEMATIC DIAGRAM .....	23 ~ 30
• FRONT PANEL CONTROLS .....	4	• WIRING CONNECTION DIAGRAM .....	31
• EQUIPMENT CONNECTIONS .....	5	• PRINTED CIRCUIT BOARD .....	32 ~ 37
• SPEAKER CONNECTIONS .....	6	• CABINET PARTS LOCATION .....	38
• BASIC OPERATIONS .....	7 ~ 8	• REPLACEMENT PARTS LIST .....	39 ~ 40
• LISTENING TO RADIO BROADCASTS .....	9 ~ 11	• RESISTORS & CAPACITORS .....	41 ~ 43
• MAKING A RECORDING .....	12	• PACKING MATERIALS & ACCESSORIES .....	44
• SLEEP TIMER FUNCTION .....	13	• PACKAGING .....	44
• OPERATION CHECKS .....	14 ~ 17		

**■ Before Repair and Adjustment**

Disconnect AC power, discharge four Power Supply Capacitors (C703 to C706) through a 10Ω, 5W resistor to ground. DO NOT SHORT-CIRCUIT DIRECTLY (with a screwdriver blade, for instance), as this may destroy solid state devices. After repairs are completed, restore power gradually using a variac, to avoid overcurrent.

Current consumption at 230V - 240V, 50Hz in NO SIGNAL mode should be between 130mA to 190mA.

**■ Protection Circuitry**

The protection circuitry may have operated if either of the following conditions are noticed :

- No sound is heard when the power is turned on.
- Sound stops during a performance.

The function of this circuitry is to prevent circuitry damage if, for example, the positive and negative speaker connection wires are "shorted", or if speaker systems with an impedance less than the indicated rated impedance of the amplifier are used.

If this occurs, follow the procedure outlines below:

1. Turn off the power.
2. Determine the cause of the problem and correct it.
3. Turn on the power once again after one minute.

**Note:**

When the protection circuitry functions, the unit will not operate unless the power is first turned off and then on again.

## ■ Caution for AC Mains Lead



(For "EB" area code model only.)

For your safety, please read the following text carefully.

This appliance is supplied with a moulded three pin mains plug for your safety and convenience.

A 5-ampere fuse is fitted in this plug.

Should the fuse need to be replaced please ensure that the replacement fuse has a rating of 5-ampere and that it is approved by ASTA or BSI to BS1362.

Check for the ASTA mark  or the BSI mark  on the body of the fuse.

If the plug contains a removable fuse cover you must ensure that it is refitted when the fuse is replaced.

If you lose the fuse cover, the plug must not be used until a replacement cover is obtained.

A replacement fuse cover can be purchased from your local dealer.

### CAUTION !

IF THE FITTED MOULDED PLUG IS UNSUITABLE FOR THE SOCKET OUTLET IN YOUR HOME THEN THE FUSE SHOULD BE REMOVED AND THE PLUG CUT OFF AND DISPOSED OFF SAFELY.

THERE IS A DANGER OF SEVERE ELECTRICAL SHOCK IF THE CUT OFF PLUG IS INSERTED INTO ANY 13-AMPERE SOCKET.

If a new plug is to be fitted, please observe the wiring code as shown below.

If in any doubt please consult a qualified electrician.

### IMPORTANT

The wires in this mains lead are coloured in accordance with the following code:

Blue:	Neutral
Brown:	Live

As these colours may not correspond with the coloured markings identifying the terminals in your plug, proceed as follows:

The wire which is coloured Blue must be connected to the terminal which is marked with the letter N or coloured Black or Blue.

The wire which is coloured Brown must be connected to the terminal which is marked with the letter L or coloured Brown or Red.

**WARNING: DO NOT CONNECT EITHER WIRE TO THE EARTH TERMINAL WHICH IS MARKED WITH THE LETTER E, BY THE EARTH SYMBOL  OR COLOURED GREEN OR GREEN/YELLOW.**

**THIS PLUG IS NOT WATERPROOF—KEEP DRY.**

### Before use

Remove the connector cover.

### How to replace the fuse

The location of the fuse differ according to the type of AC mains plug (figures A and B). Confirm the AC mains plug fitted and follow the instructions below.

Illustrations may differ from actual AC mains plug.

1. Open the fuse cover with a screwdriver.

Figure A

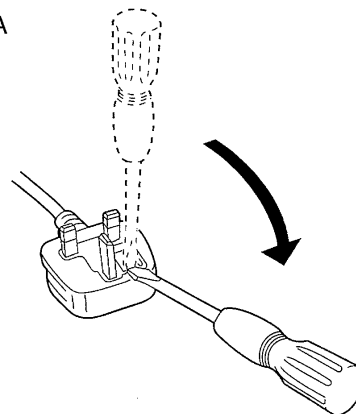
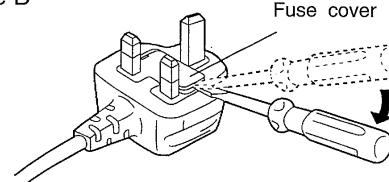

Figure B



2. Replace the fuse and close or attach the fuse cover.

Figure A

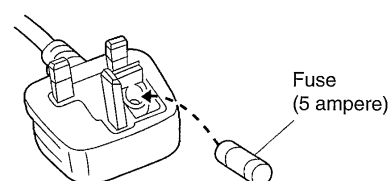
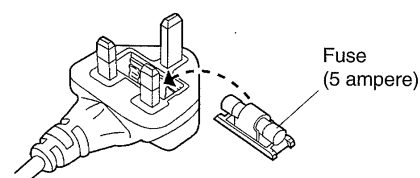
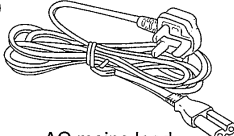
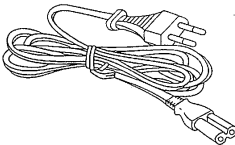
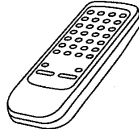
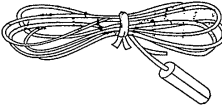
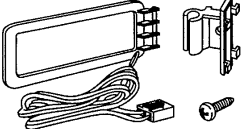



Figure B





## Accessories

<p>(EB)</p>  <p>AC mains lead (RJA005-1X ... EB) .....1 pc. (RJA0019-2K ... E/EG) .....1 pc.</p>	<p>(E/EG)</p> 	 <p>Remote control unit (EUR644858) .....1 pc</p>	 <p>FM indoor antenna (RSA0007) .....1 pc</p>
 <p>AM loop antenna set (RSA0010) .....1 set</p>	 <p>Attachment plug (SJP9009) .....1 pc.</p>		

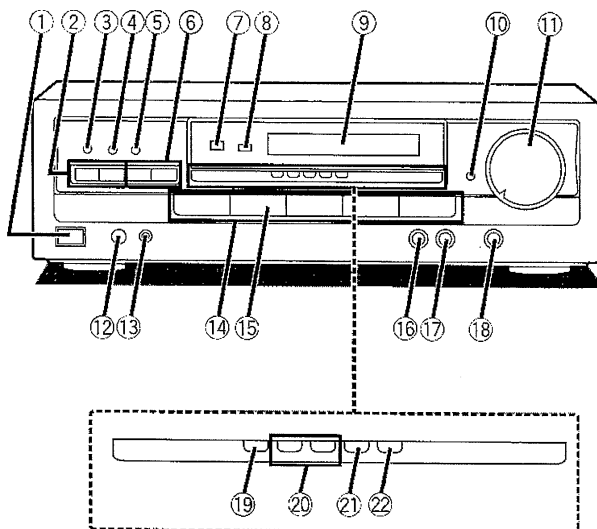
## Front Panel Controls



- ① Power "STANDBY  /ON" switch  
(POWER, STANDBY  /ON)  
Press to switch the unit from on to standby mode or vice versa.  
In standby mode, the unit is still consuming a small amount of power.
- ② Tuning buttons (TUNING)
- ③ Band select button (BAND)
- ④ FM mode select button (FM AUTO/MONO)
- ⑤ Memory button (MEMORY)
- ⑥ Preset channel buttons (PRESET)
- ⑦ Remote control signal sensor (SENSOR)
- ⑧ "STANDBY" indicator (STANDBY)  
When the unit is connected to the AC mains supply, this indicator lights up in standby mode and goes out when the unit is turned on.
- ⑨ Display
- ⑩ Muting button (MUTING)
- ⑪ Volume control (VOLUME)
- ⑫ Headphones jack (PHONES)
- ⑬ Speaker ON/OFF button (SPEAKERS)
- ⑭ Input select buttons
- ⑮ Tape monitor button (TAPE MONITOR)
- ⑯ Bass control (BASS)
- ⑰ Treble control (TREBLE)
- ⑱ Balance control (BALANCE)
- ⑲ RDS display mode select button  
(DISPLAY MODE)
- ⑳ PTY select buttons (PTY SELECT)
- ㉑ EON ON/OFF button (EON)
- ㉒ PTY search button (SEARCH)

## Equipment connections

Make sure that the power supply for all components has been turned off before making any connections.

Refer to the operating instructions of the equipment to be connected.

### Note

Do not place books, etc., on the top of this unit or block the heat radiation vents in any way.

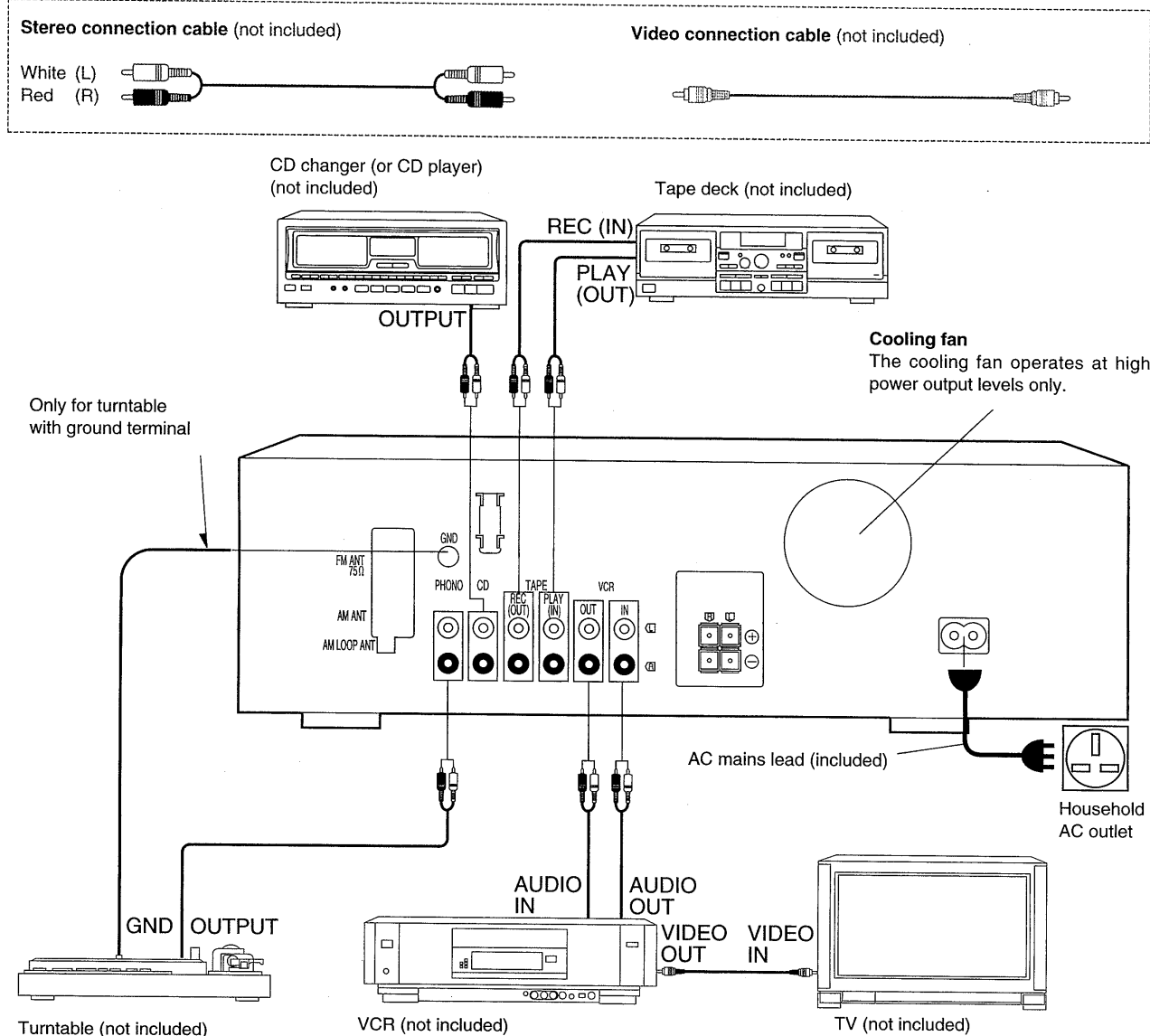

### AC mains lead

**BE SURE TO READ THE CAUTION FOR THE AC MAINS LEAD ON PAGE 3 BEFORE THE FOLLOWING CONNECTION.**

Connect this mains lead after all other cables and cords are connected.

#### Insertion of Connector

Even when the connector is perfectly inserted, depending on the type of inlet used, the front part of the connector may jut out as shown in the drawing. However there is no problem using the unit.

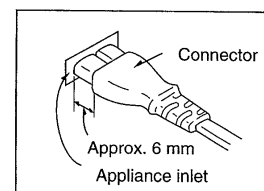

## ■ Speaker connections

### Connecting the speaker cable

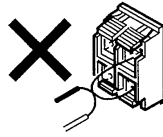
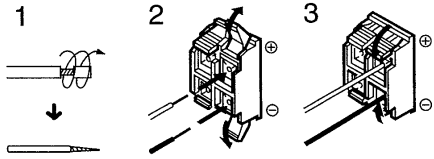

**Note**

To prevent damage to circuitry, never short-circuit positive (+) and negative (-) speaker wires.

### Connecting speakers

**Note**

Other connections are possible depending on the speaker system you have. For details, see the operating instructions that came with your speaker system.

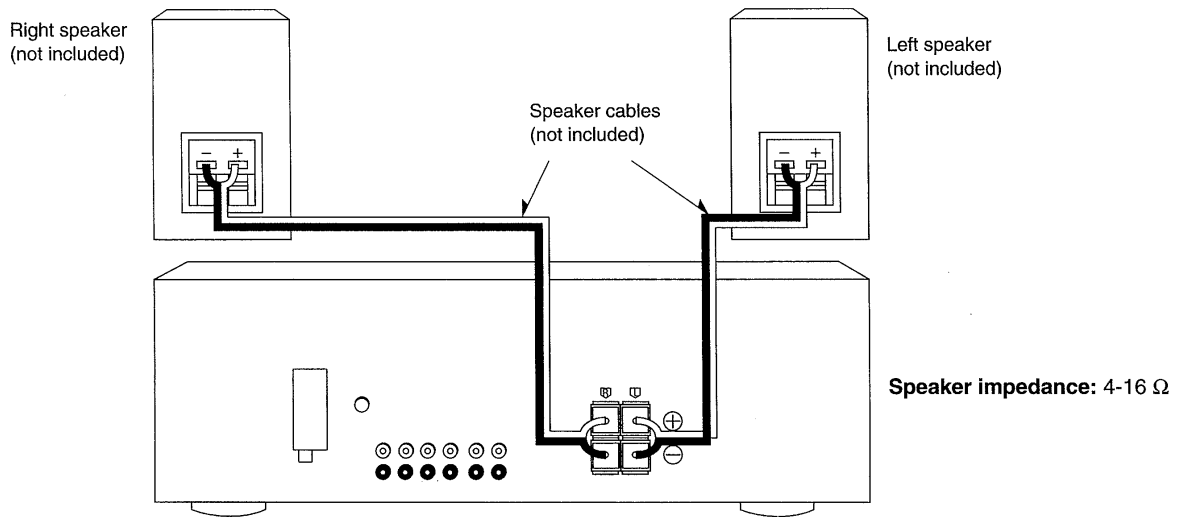

## Basic operations

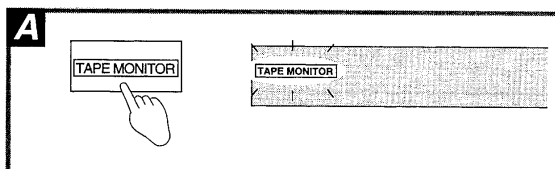
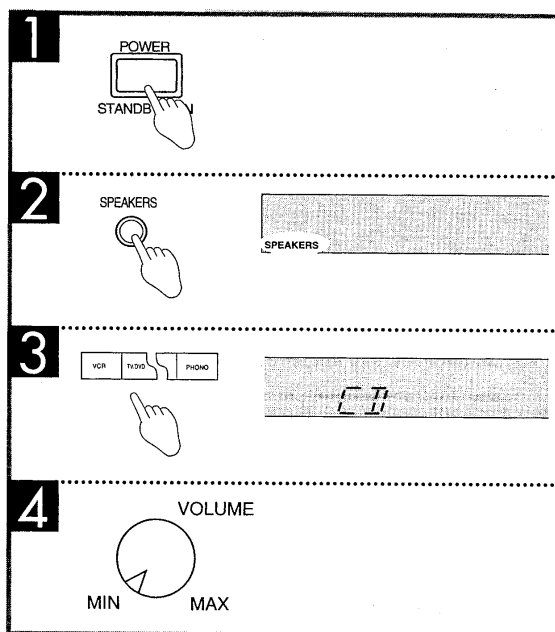
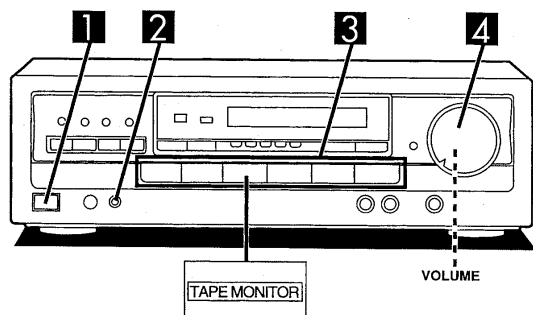

Before operation, set VOLUME to the "MIN" position.

- 1** Press POWER.
- 2** Press SPEAKERS and check the "SPEAKERS" indication lights up.

If the button is pressed once more, the indicator will switch off and no sound will be heard from the speakers.

- 3** Select and start the desired source.  
(Refer to the appropriate operating instructions for details.)

**VCR:** To watch video tapes (VCR)

**TAPE MONITOR:** To listen to cassette tapes (The "TAPE MONITOR" indicator will appear.) (See below.)

**CD:** To listen to compact discs

**TUNER:** To listen to radio broadcasts

**PHONO:** To listen to phono discs

- 4** Adjust the volume level.

### After you are finished

Be sure to reduce the volume, and switch the power to the standby condition by pressing POWER.

### When the tape monitor indicator is lit or flashing **A**

This indicates that the tape monitor function of this unit is ON.

To listen to sources other than a tape, be sure to press TAPE MONITOR and check the indicator goes out.

## Basic operations

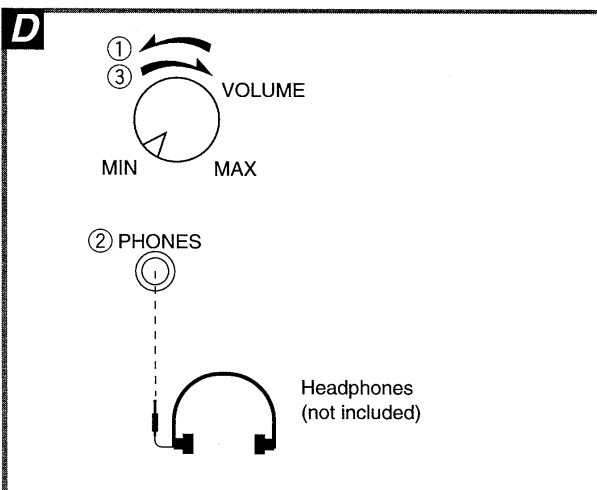
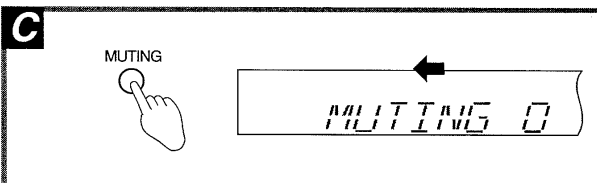
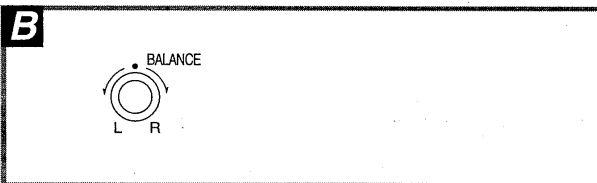
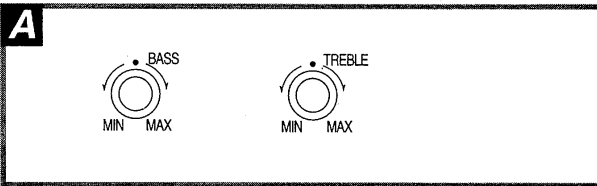
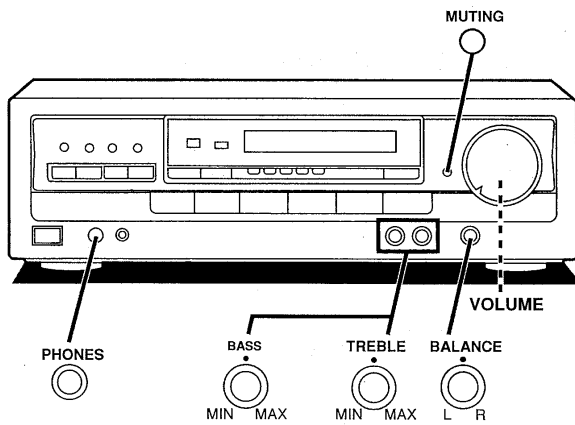

### To adjust the tone quality **A**

Turn **BASS** to adjust the low frequency sound.  
Turn **TREBLE** to adjust the high frequency sound.

### To adjust the sound balance **B**

Turn **BALANCE** to adjust the left/right sound balance.

### To mute the sound level **C**

#### Press **MUTING**.

The message "MUTING ON NOW" runs repeatedly from right to left across the display as long as the muting function is on.

Press once again to return to the previous volume level.

#### Note

When the receiver is turned off, the muting operation will be automatically cancelled.

### To listen through headphones **D**

- ① Reduce the volume level.
- ② Connect the headphones.  
Plug type: 6.3 mm stereo
- ③ Adjust the volume level.

If you do not want sound from the speakers, press the **SPEAKERS** and check the speaker indicator goes out.

#### Note

Avoid listening for prolonged periods of time to prevent hearing damage.



## ■ Listening to radio broadcasts

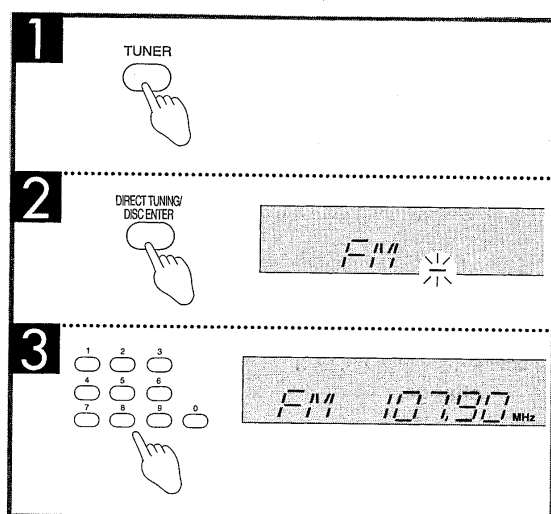
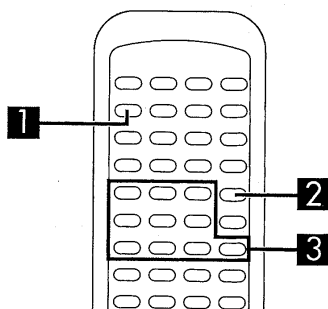
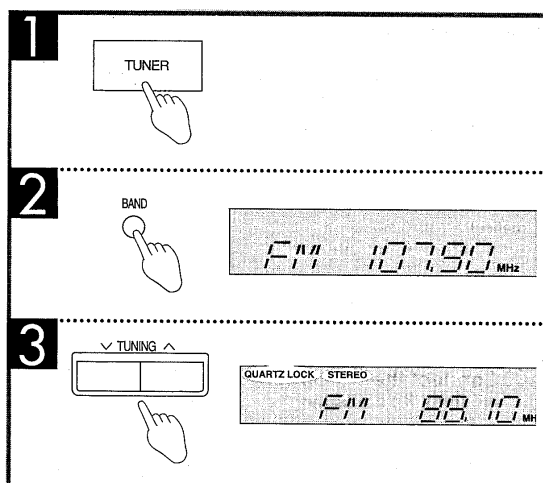
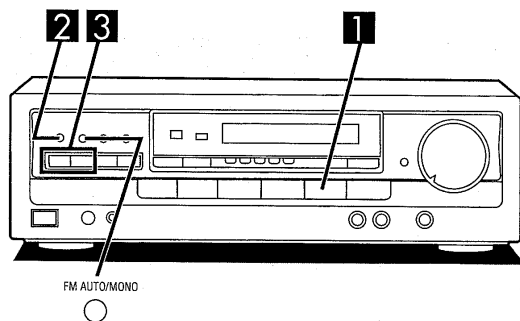

### Sequential tuning

You can use the tuning buttons to tune-in radio stations.

- 1** Press **TUNER**.
- 2** Press **BAND** to select "FM" or "AM".
- 3** Press **TUNING** (∇) or (∧) to tune to the desired frequency.

"QUARTZ LOCK" lights up when tuned.

"STEREO" lights up when an FM stereo broadcast is received.

#### To make an automatic search for broadcast stations

If TUNING (∇) or (∧) is held down for an instant until the frequency begins to scroll, the broadcast stations are tuned in automatically when found.

#### Note

Tuning may stop automatically if any jamming is encountered.

#### If noise is excessive in the FM stereo mode

Press FM AUTO/MONO.

(The "STEREO" indicator will go out, and the "MONO" indicator will light up.)

The broadcast will be monaural, but noise will be reduced.

If the button is pressed once more, the stereo mode will be resumed.

### Direct tuning

(Only available from the remote control.)

Specify the frequency using the numeric buttons on the remote control transmitter to directly tune to a station.

First select between FM and AM with the BAND button on the receiver.

- 1** Press **TUNER**.  
This will set the remote control to operate the tuner.
- 2** Press **DIRECT TUNING/DISC ENTER**.
- 3** While cursor is flashing (approx. 10 seconds)  
Press the numeric buttons to enter the frequency.

If the desired FM frequency is 107.90 MHz, press  
1 → 0 → 7 → 9 → 0

The frequency will blink once and the station will be tuned in.

#### Note

1. If no button is pressed while the cursor display is flashing, the display will return to the frequency which is currently being received. To re-specify the frequency, repeat the procedure from step 2.
2. If the frequency was not input correctly, "ERROR" is displayed. In this case, re-enter the frequency.

## ■ Listening to radio broadcasts

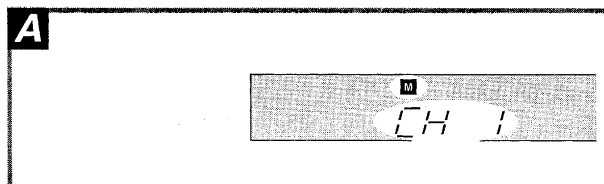
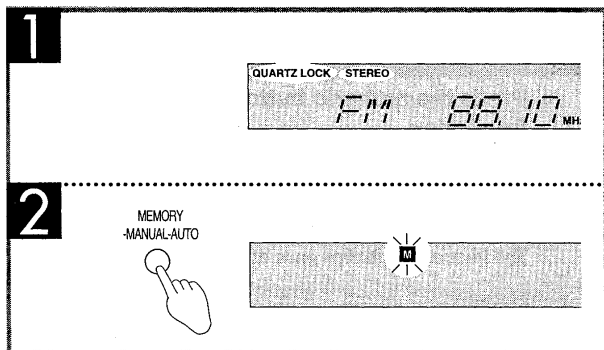
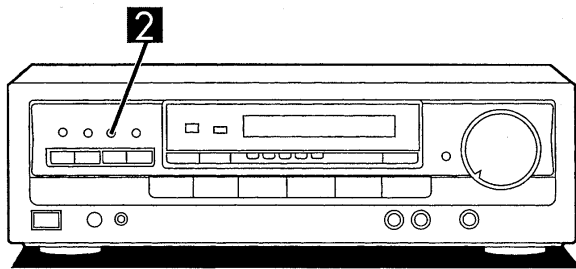

### Preset tuning

Presetting radio stations into the memory channels of this unit makes selecting stations simple.

A total of 30 FM and AM stations can be preset.

#### Please remember this

If a new broadcast station is preset into a channel, the setting for the broadcast station which was previously entered in that channel will be automatically erased.

#### Automatic memory presetting

Automatic memory presetting allows this unit to automatically search for broadcast stations and then preset them into memory. With this method, the channels that can be preset into the memory are set as follows for different bands (FM or AM).

#### When FM stations are preset,

For FM stations .....1-30

#### When FM and AM stations are preset,

For FM stations .....1-20

For AM stations .....21-30

**1** Set to the frequency from which you want to start automatic memory presetting.

**2** Press MEMORY until the frequency begins to change.

(Automatic memory presetting will start.)

During automatic memory presetting, the memory indicator will flash while the frequency scrolls.

To stop, press MEMORY once again.

#### When a broadcast station is preset

The memory indicator and the preset channel number will be displayed for approximately 1 second.

#### When presetting is completed

The last broadcast station to be preset will be displayed.

#### Note

Frequencies may not be preset correctly in cases where the broadcast waves are too strong or too weak. In such cases, carry out pre-setting manually.

## ■ Listening to radio broadcasts

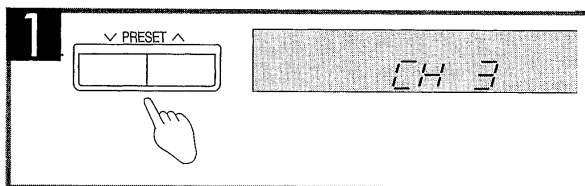
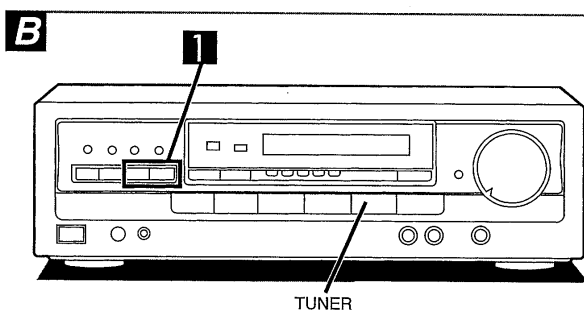
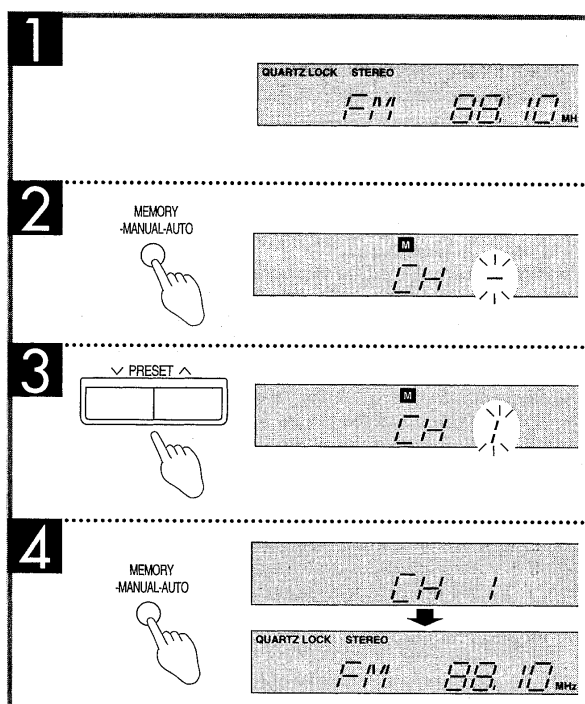
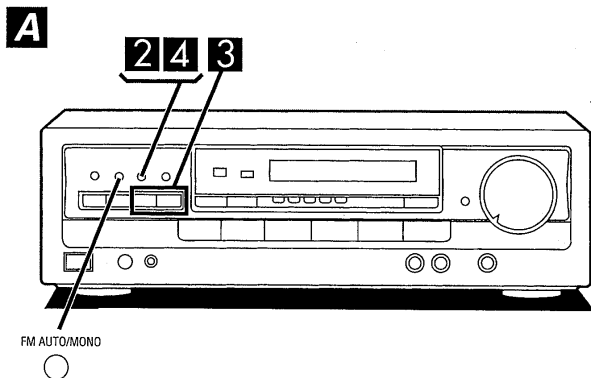

### Manual memory presetting **A**

The desired stations can be preset into the desired channels by the user.

- 1 Set to the desired frequency.**  
If interference or static is keeping you from enjoying an FM station, press FM AUTO/MONO and change to monaural. The station is preset in monaural if this is done.
- 2 Press MEMORY.**  
To cancel the memory function, press MEMORY again.
- 3 Press PRESET (∇) or (▲) to select the desired channel.**  
Holding the buttons down lets you scroll through channels faster.
- 4 Press MEMORY.**  
The channel will blink on the display.

**To continue presetting**  
Repeat steps 1 through 4.

### To listen to preset channels **B**

- 1 Press PRESET (∇) or (▲) to select the desired channel.**  
Holding the buttons down lets you scroll through channels faster.

**To confirm the channel number of the broadcast station being received**  
Press TUNER.  
(The channel number will be displayed for approximately 1 second.)

#### Note

The channel number is not displayed if you change the reception frequency or FM mode setting.

#### For your reference

Even if the power cord is disconnected from the household AC outlet, the memory will retain its contents for approximately one month.

#### If frequency presettings are accidentally erased

Program the presettings once again.  
The power cord should remain connected for one hour or more for the memory back-up to be effective.

## ■ Making a recording

### A

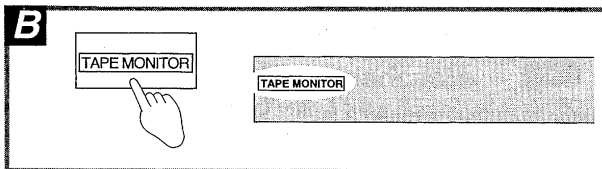
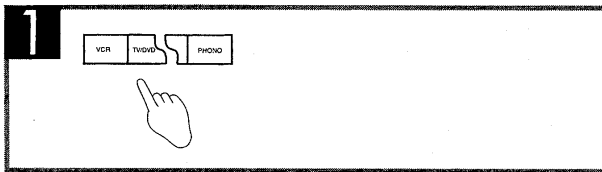
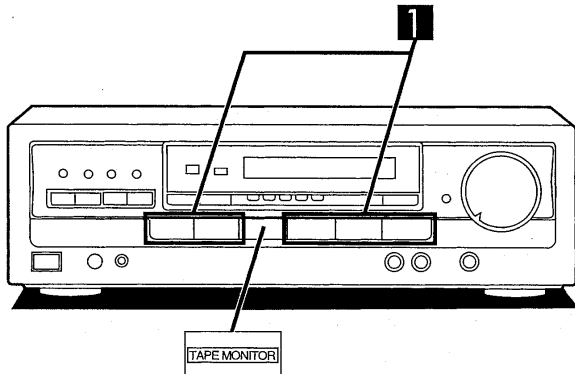

### C

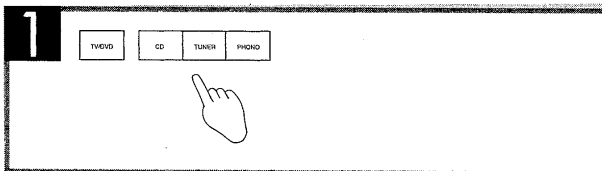
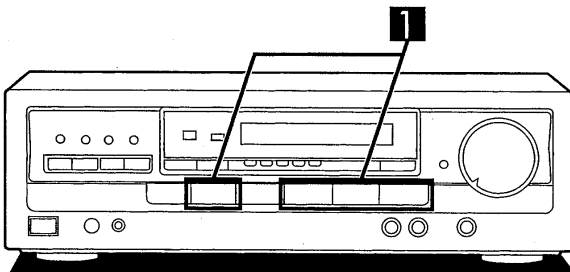

### Recording on a tape deck A

Before recording, prepare the tape deck for recording (recording level adjustment, etc.).

See the tape deck's operating instructions for details.

- 1 Select the source to be recorded.**  
Any source can be selected except **TAPE MONITOR**.
- 2 Begin recording on the tape deck.**  
Follow your tape deck's operating instructions.
- 3 Begin the desired source to be recorded.**  
Follow your equipment's operating instructions.

### To check the sound recorded while a recording is being made E

It is possible to check the sound being recorded if your tape deck is a 3 head system.

Press **TAPE MONITOR** on this unit and set the monitor button on the tape deck to "TAPE".

Press **TAPE MONITOR** once again to turn it off.

### Recording on a VCR C

Before recording, prepare the VCR for recording (recording level adjustment, input selector setting, etc.).

See the VCR's operating instructions for details.

- 1 Select the source to be recorded.**  
Any source can be selected except VCR and **TAPE MONITOR**.

#### Note

Recording from a tape deck is not possible.

- 2 Begin recording on the VCR.**  
Follow your VCR's operating instructions.
- 3 Begin the source to be recorded.**  
Follow your equipment's operating instructions.

## ■ Sleep timer function

A

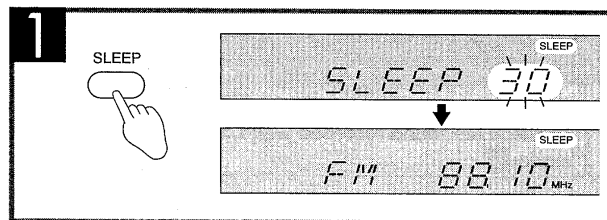
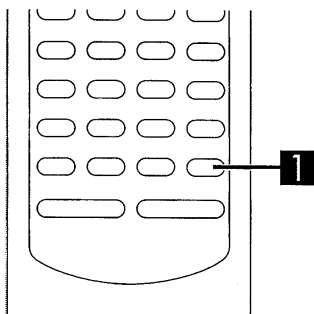

### (Only available from remote control)

This feature turns the unit off for you after a set time. It can be set for 30, 60, or 90 minutes.

#### Note

The sleep timer turns off the receiver, but it does not turn off any external components.

1

(While listening to the radio)

#### Press SLEEP to set the desired time.

The "SLEEP" indicator will appear on the display.

Each time the button is pressed, the indicator will change in the order:

30 → 60 → 90 → OFF



The display returns to the way it was before in about 5 seconds.

#### To cancel the sleep timer

Press SLEEP until "OFF" is displayed. The "SLEEP" indicator will go out.

#### To check how much time is left (while the timer is running)

Press SLEEP once.

#### Note

Do not press SLEEP again before the remaining time display goes out.

If you do so, the timer will return to the setting mode.

#### To change the set time while the timer is running

1. Press SLEEP.
2. Press SLEEP again while the remaining time is displayed and then reset the timer (30, 60 or 90 minutes.)

## ■ Operation Checks

**"ATTENTION SERVICER"** Some chassis components may have sharp edges. Be careful when disassembling and servicing.

1. This section describes procedures for checking the operation of the major printed circuit boards and replacing the main components.
2. For reassembly after operation checks or replacement, reverse the respective procedures. Special reassembly procedures are described only when required.
3. Select items from the following index when checks or replacement are required.

• **Contents**

	page
• Checking Procedure For Each Major P.C.B. ....	14~ 16
• Replacement of Power IC and Regulator Transistor .....	17

## ■ Checking Procedure For Each Major P.C.B.

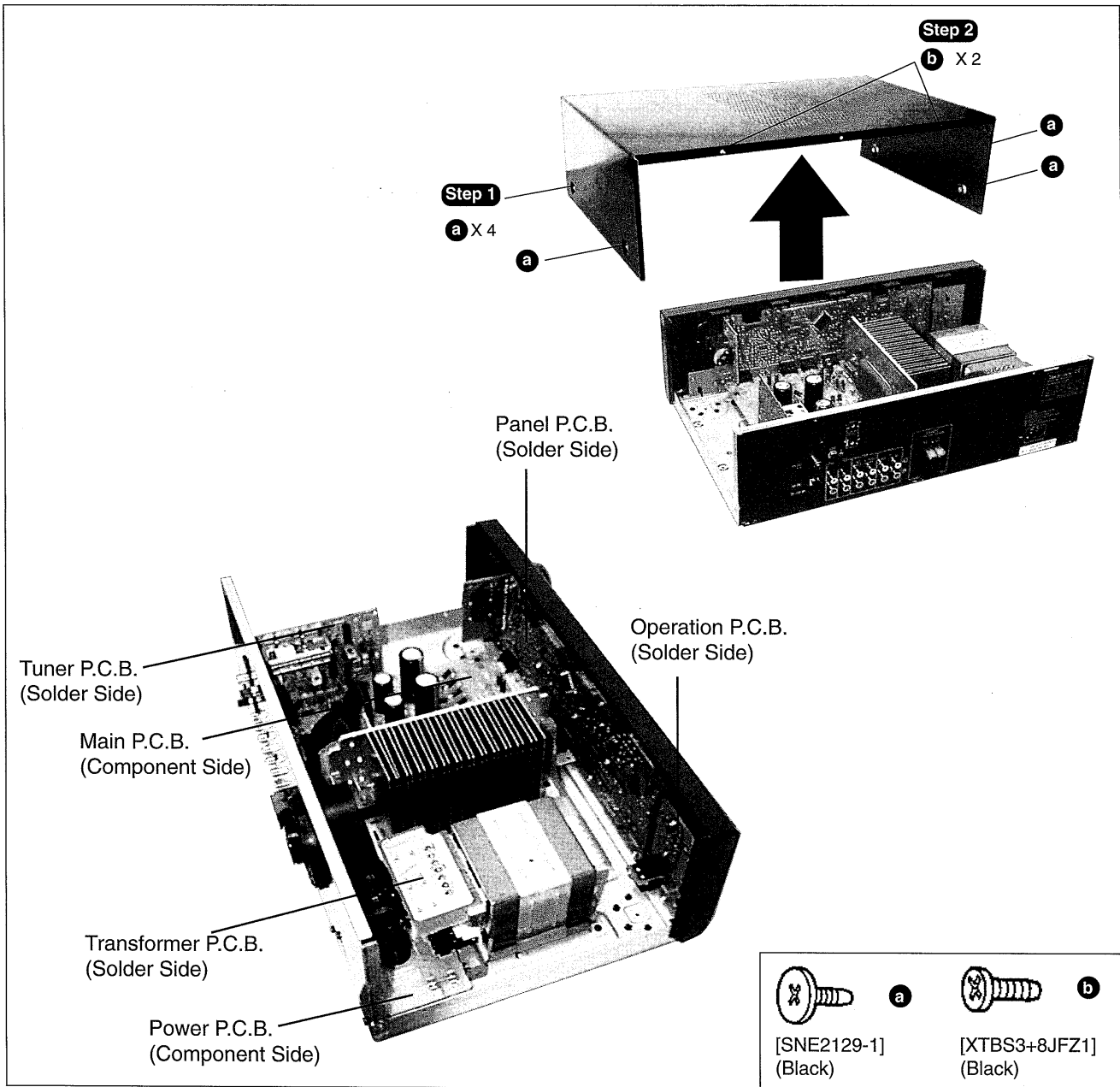

To remove Front Panel and check Panel P.C.B. , Operation P.C.B. and Headphone Jack P.C.B.

**Step 1**

Remove the top cabinet.

**Step 2**

**b** X 3

**Step 3**

Remove the Front Panel in the direction of arrow.

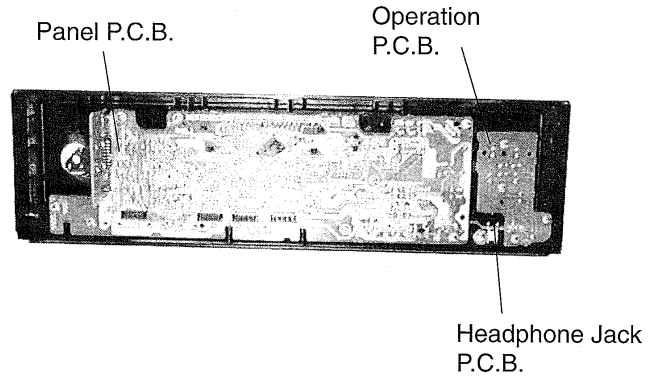
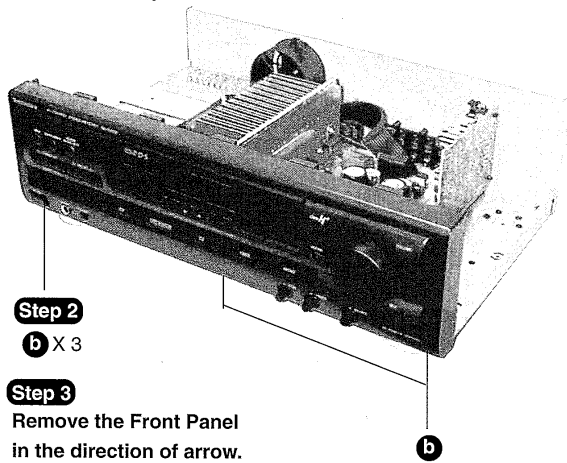

To remove Rear Panel and check Main P.C.B., Power P.C.B., Transformer & Tuner P.C.B.

**Step 4**

Pull out the rear panel in the direction of arrow.

**Step 1**

Remove the top cabinet.

**Step 2**

Remove the front panel.

**Step 5**

Release the fan motor connector

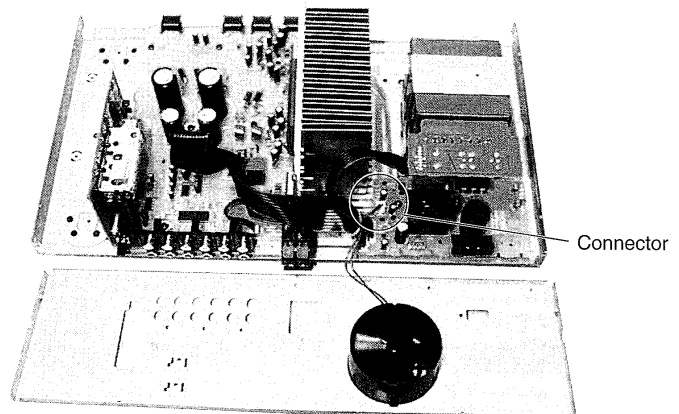
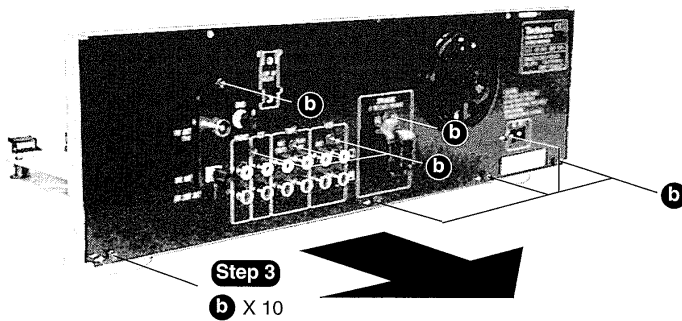

**Step 6**

Fix back the front panel and connect the four connector (CN901 to CN904).

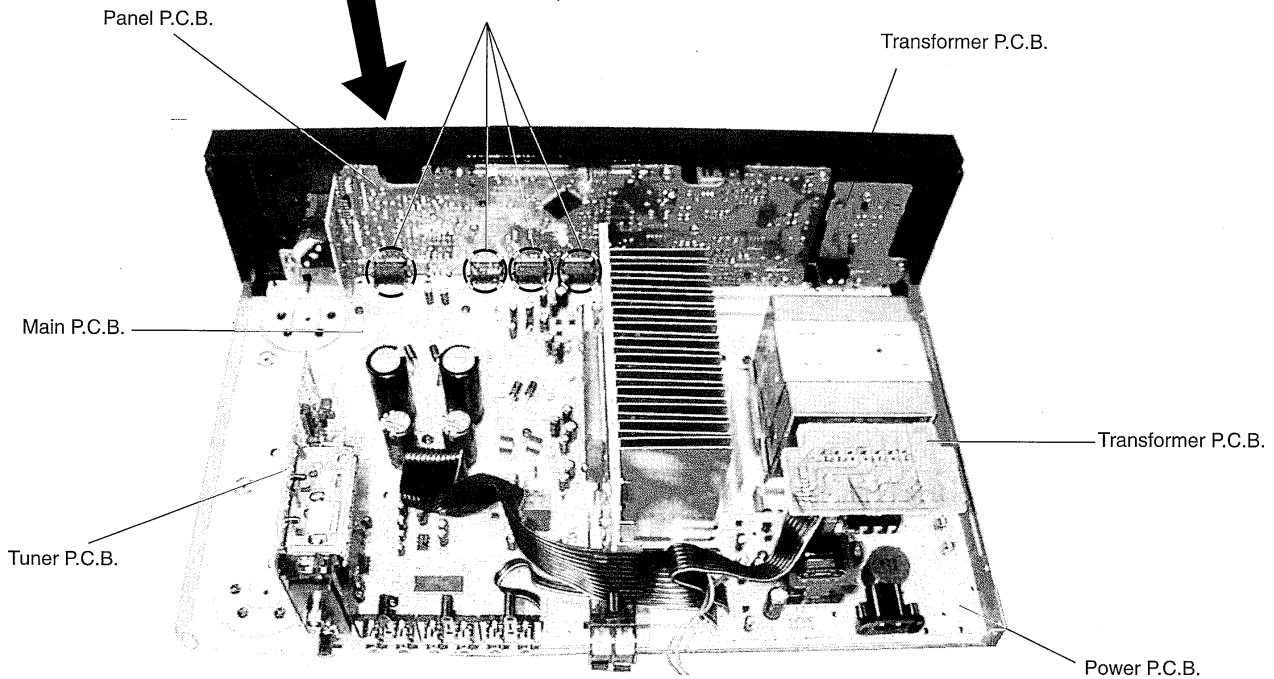

**Step 7**

Check the Main P.C.B., Panel P.C.B., Transformer P.C.B., Tuner P.C.B. and Power P.C.B.

**CAUTION**

1. After replacing the power IC or regulator transistor, apply a sufficient quantity of compound grease (RFKX0002/SZZ0L15) between the heat sink and the power IC or regulator transistor (Radiation of power IC).
2. Tighten enough the screws after replacing the power IC and regulator transistor. Otherwise, the heat radiation works little.
3. When installing or removing the power IC or transistor holder, be sure to use an offset screwdriver.
  - A long straight screwdriver cannot be used for removing or mounting the screws since its long grip interferes with the neighbouring P.C.B. (See Fig.1)
  - A short straight screwdriver may be used for removal, but cannot be used for mounting because the limited space in the unit will not allow sufficient tightening torque.(See Fig.2)

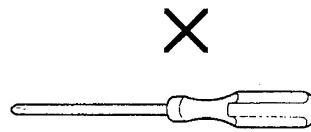

A long straight screwdriver

**Fig.1**

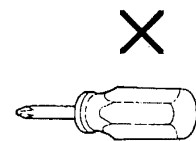

A short straight screwdriver

**Fig.2**

- Insufficient tightening will cause poor heat dissipation from the power IC and regulator transistor and, in the worst case, may lead to their thermal breakdown.



## ■ Replacement of Power IC and Regulator Transistor

Locate the nipper to the thin portion of the joint.

Nipper

Cut the joint.

Bottom chassis ass'y

Bottom cover

1. Cut the joints (6 portions) between bottom cover and bottom chassis ass'y with nipper.

2. After cutting the joints (6 portions), bend the portions of the bottom chassis ass'y in the direction of arrow with pliers.

3. When replacing the power IC or regulator transistor, unsolder the terminals of power IC or regulator transistor on the soldered surface.

4. Then remove the screws fixed to the power IC or transistor holder.

5. When installing or removing the power IC or transistor holder, be sure to use an offset screwdriver.

6. After replacing the power IC or regulator transistor, upset the bottom cover and align the ribs of the bottom cover to the lugs on the bottom chassis ass'y.

7. After mounting the bottom cover on the bottom chassis ass'y, fix it with a screw (XTB3+8J).

CAUTION

- After replacing the power IC or regulator transistor, apply a sufficient quantity of compound grease (RFKX0002) between the heat sink and the power IC or regulator transistor. (Radiation of power IC & transistor)
- Tighten enough the screws after replacing the power IC or regulator transistors. Otherwise, the heat radiation works little.

Offset screwdriver

Transistor holder

Power IC

Regulator transistor

Screw (XTB3+8J)

Ribs

Bottom cover

Bottom chassis ass'y

Lugs

Bottom cover

\*Upset the bottom cover

■ Block Diagram

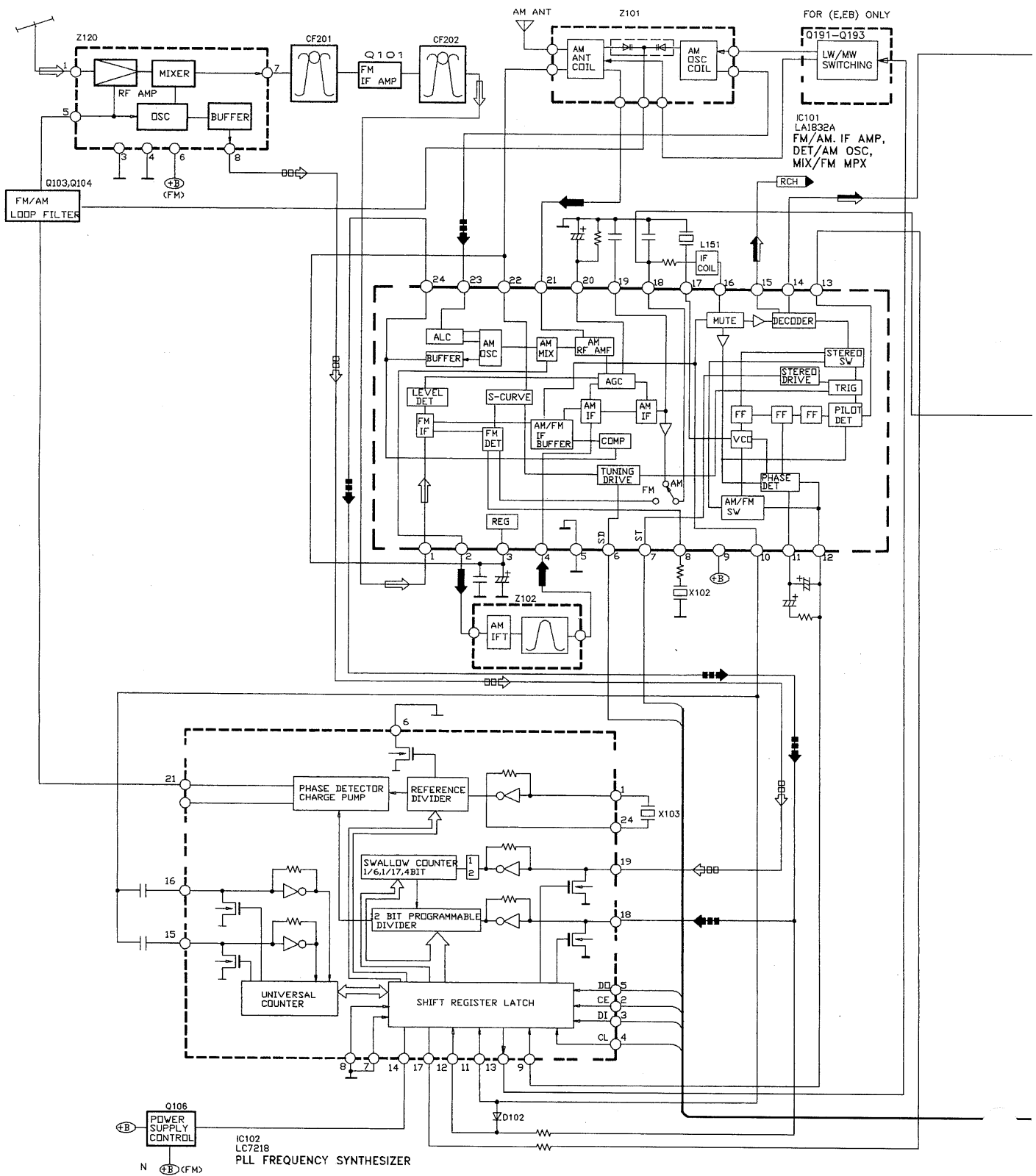

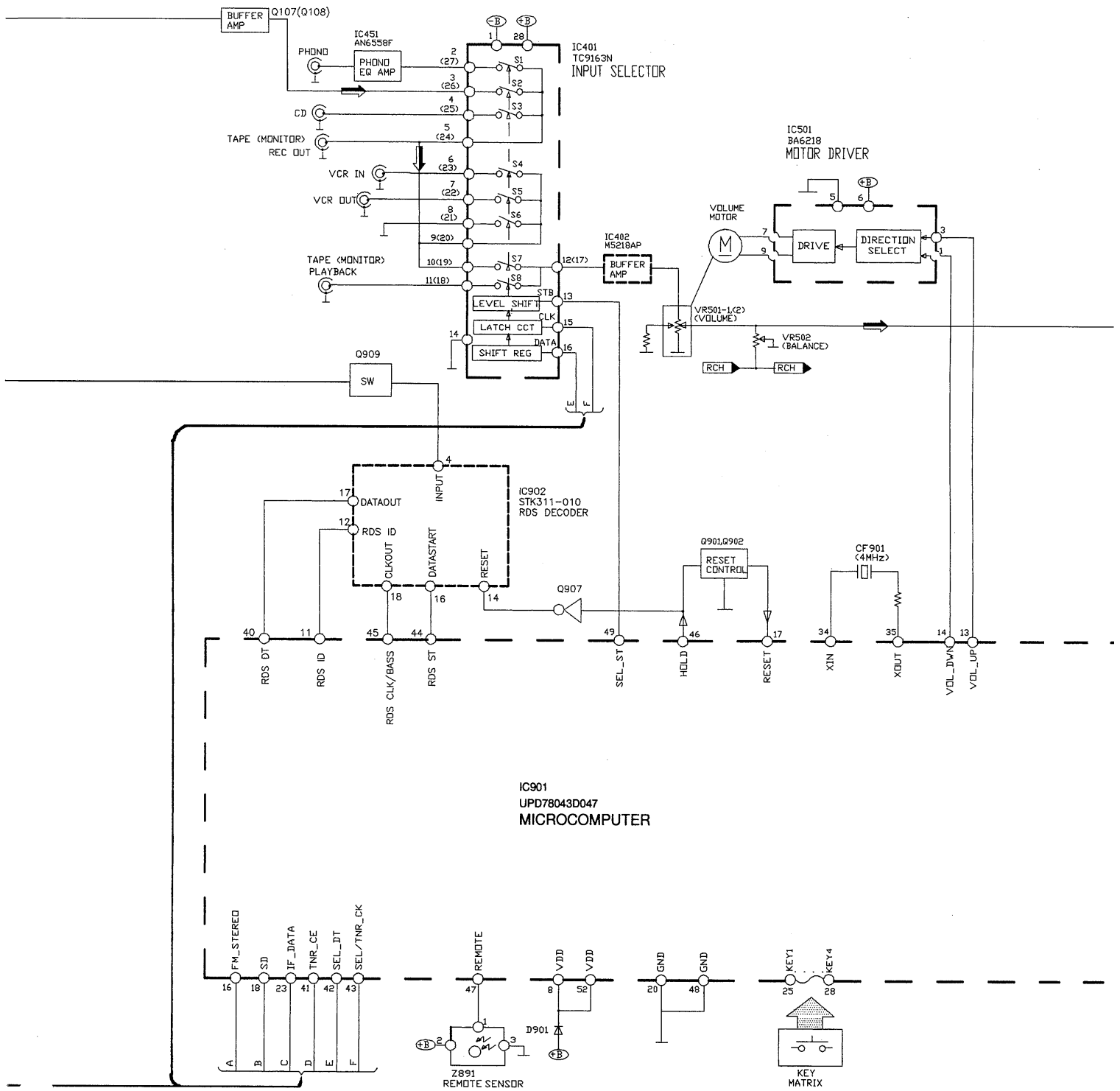

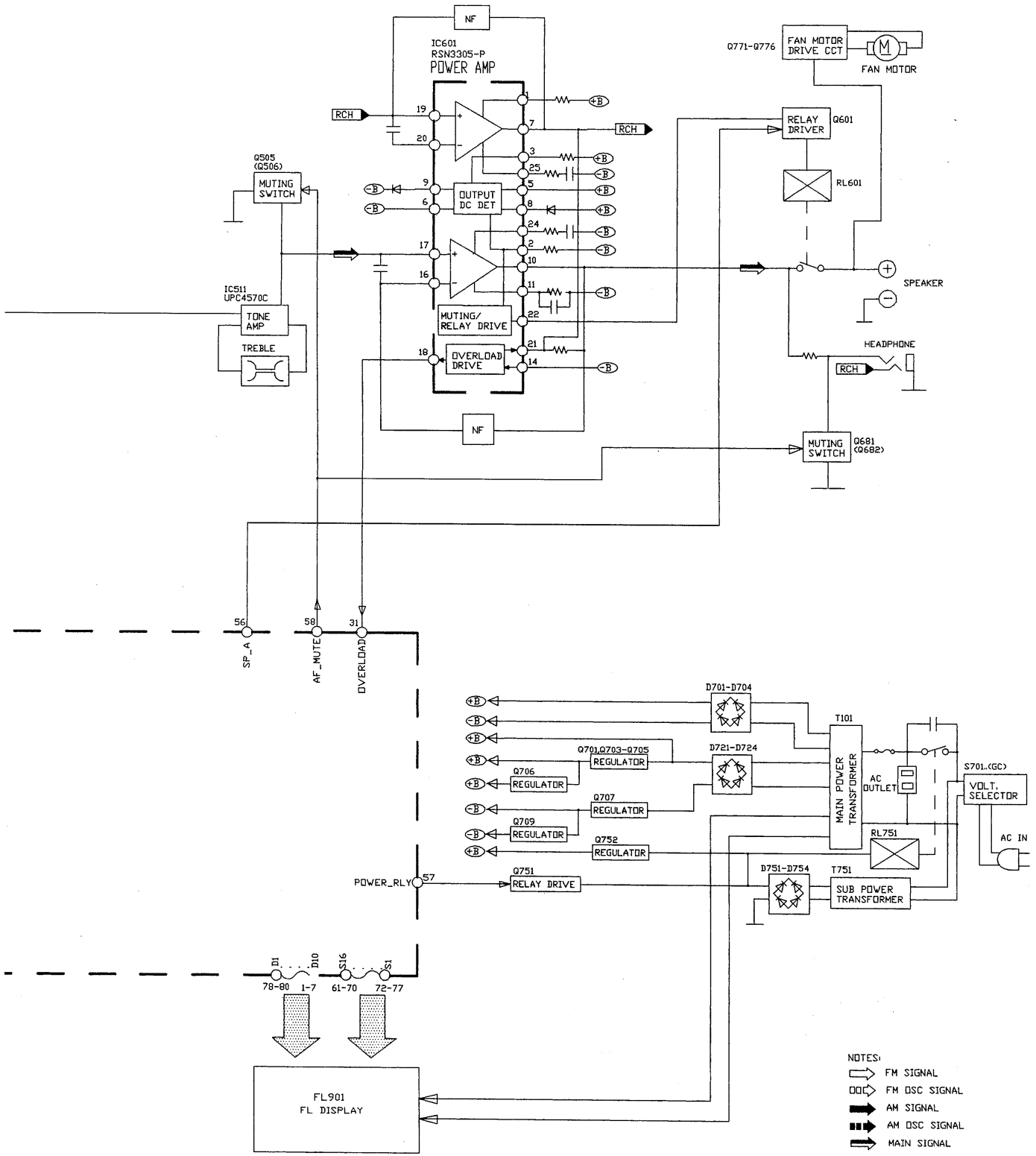

## ■ Terminal Functions Of ICs

### • IC901 (M38B57M6101F) System Microprocessor

Pin No.	Mark	I/O	Function
1~2	KEY2~KEY1	I	Key Input 1 ~ 2
3	THERM/OVLD1	I	Thermal/Over load input 1
4	KEY4	I	Key Input 4
5	THERM/OVLD2	I	Thermal/Over load input 2
6	FM_ST	I	Stereo signal detect terminal
7	WAKE_LED	O	Wake up timer LED
8	RDS_ST	I	Control of RDS IC (ST) stereo signal
9	REMOTE	I	Remote control terminal
10	RESET	–	Reset detect terminal
11	RDS_CK	I	Control of RDS IC (CK) clock signal
12	RDS_DT	I	Control of RDS IC (DT) data signal
13	GND	–	GND terminal
14	OCS	–	Crystal oscillator terminal ( 4 MHz )
15	OCS	–	Crystal oscillator terminal ( 4 MHz )
16	VDD (+5V)	–	Power supply terminal +5V
17	LED_IC_CK	O	LED driver IC (CK) clock signal
18	LED_IC_DT	O	LED driver IC (DT) data signal
19	SFC/PTY_ENCD1	I	SFC mode encoder input 1
20	SFC/PTY_ENCD2	I	SFC mode encoder input 2
21	SEL_ENCD1	I	Selector encoder for input 1
22	HOLD	I	Blackout detection terminal
23	SEL_ENCD2	I	Selector encoder for input 2
24	FRT_VCR2	I	VCR2 control input
25	RELAY	–	Relay control output
26	ABS	O	ABS control output
27	6ch_SW_ST	O	6 ch sw control output (ST)
28	Vee (-22V)	–	Power supply for FL driver
29	S/C_SP	O	Surround/Center speaker control output

Pin No.	Mark	I/O	Function
30	SP_B	O	Speaker B control output
31	SP_A	O	Speaker A control output
32	AF_MUTE	O	Muting control output
33~48	SEG16~SEG1	O	FL segment signal output
49~58	DEG1~DEG10	O	FL digit signal output
59	INIT_IN	I	Diode input initial settings
60	VOL_DOWN	O	Volume control output (Down)
61	VOL_UP	O	Volume control output (Up)
62	REC_MUTE	O	REC Mute control
63	IF_DATA	I	Serial data signal
64	LIMITTER	O	Power limiter control output
65	TNR_CE	O	Tuner control (CE) chip enable signal
66	SEL/TNR_CK	O	Selector/Tuner (CK) clock signal
67	SEL/TNR_DT	O	Selector/Tuner (DT) data signal
68	SEL_ST	O	Selector control terminal
69	MMD_CTRL	O	MMD control terminal
70	SURR_CK	O	Surround control (CK) clock signal
71	SURR_DT	O	Surround control (DT) data signal
72	SURR_CE	O	Surround control (CE) chip enable signal
73	AVSS	–	GND for A-D converter
74	VREF	–	Reference voltage for A-D converter
75	SD	I	SD signal detect input
76	SUR_ENCD1	I	Encoder of surround mode selector input1
77	HELP_LED	O	Help LED control output
78	SUR_ENCD2	I	Encoder of surround mode selector input2
79	VIDEO_A	O	Video selector control output A
80	VIDEO_B	O	Video selector control output B

## Terminal Guide of ICs, Transistors and Diodes

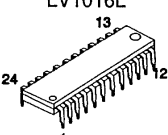
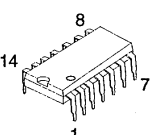
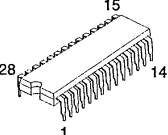
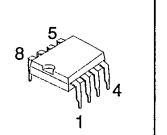
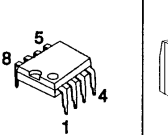
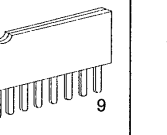
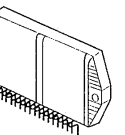
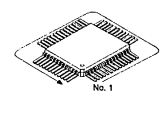
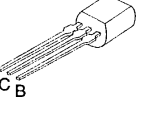
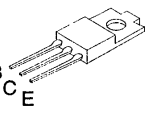
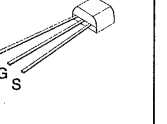
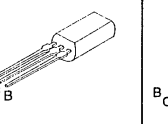
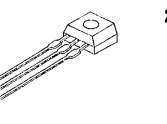
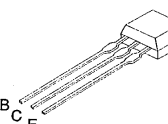
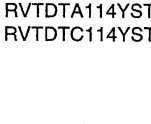
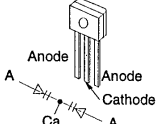
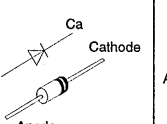
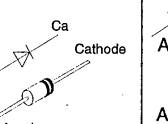
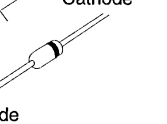
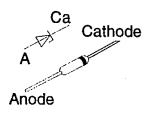
<p>LA1832A LC7218 LV1016L</p> 	<p>M5218AP</p> 	<p>TC9163AN</p> 	<p>UPC4570C</p> 	<p>AN6558F</p> 	<p>BA6218</p> 	<p>RSN3305-P</p> 
<p>M38B53M4055F LC72721N</p> 	<p>2SB621AQSTA</p> 	<p>2SD2374PQAU</p> 	<p>SB360L6508</p> 	<p>2SC3940AQSTA</p> 	<p>2SC2785FETA</p> 	<p>2SC2787FL1TA 2SC2787LTA 2SD1915FTA 2SC3311ARTA</p>
<p>2SC1740SSTA</p> 	<p>RVTDTA143XST RVTDTC143XST RVTDTA114YST RVTDTC114YST</p> 	<p>SVC211SPA-AL</p> 	<p>LN846RPH</p> 	<p>1N5402BM21</p> 		<p>RVD1SS133TA 1SR35200TB MA700ATA 1SS291TA MA167ATA MA165TA</p>
<p>MTZJ16CTA MTZJ24DTA</p> 	<p>MTZJ3R9ATA MTZJ4R7BTA MTZJ5R1BTA MTZJ6R2BTA MTZJ6R8BTA MTZJ7R5CTA</p>					

## ■ Schematic Diagram

(All schematic diagrams may be modified at any time with the development of new technology)

### Note :

• S946	:	Power switch	• S964	:	VCR switch
• S947	:	PHONO switch	• S970	:	Search switch
• S948	:	Muting switch	• S971	:	Eon switch
• S950	:	FM Mode switch	• S972	:	Pty select up switch
• S951	:	Band select switch	• S973	:	Pty select down switch
• S952	:	Tuning decrease switch	• S974	:	Display mode switch
• S953	:	Tuning increase switch	• S976	:	DVD 6CH switch
• S955	:	Memory switch	• S980	:	Speakers switch
• S956	:	CH/DOWN switch	• VR501	:	Volume control
• S957	:	CH/UP switch	• VR502	:	Balance control
• S960	:	Tuner switch	• VR511	:	Bass control
• S961	:	CD switch	• VR512	:	Treble control
• S962	:	Tape switch			

### • Signal line

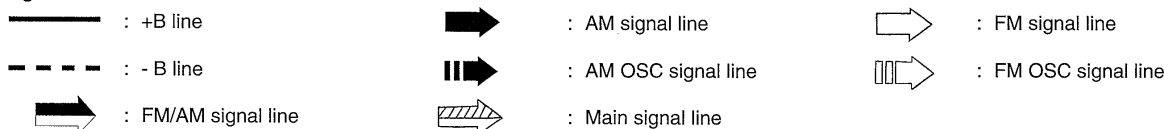

- The voltage value and waveforms are the reference voltage of this unit measured by DC electronic voltmeter (high impedance) and oscilloscope on the basis of chassis. Accordingly, there may arise some error in voltage values and waveforms depending upon the internal impedance of the tester or the measuring unit.

< > ..... FM      NO MARK ..... TAPE      ( ) ..... AM

### • Importance safety notice:

Components identified by  $\Delta$  mark have special characteristics important for safety. Furthermore, special parts which have purposes of fire-retardant (resistors), high-quality sound (capacitors), low-noise (resistors), etc. are used. When replacing any of components, be sure to use only manufacturer's specified parts shown in the parts list.

### Caution !

IC, LSI and VLSI are sensitive to static electricity.

Secondary trouble can be prevented by taking care during repair.

- Cover the parts boxes made of plastics with aluminium foil.
- Ground the soldering iron.
- Do not touch the pins of IC, LSI or VLSI with fingers directly.
- Put a conductive mat on the work table.

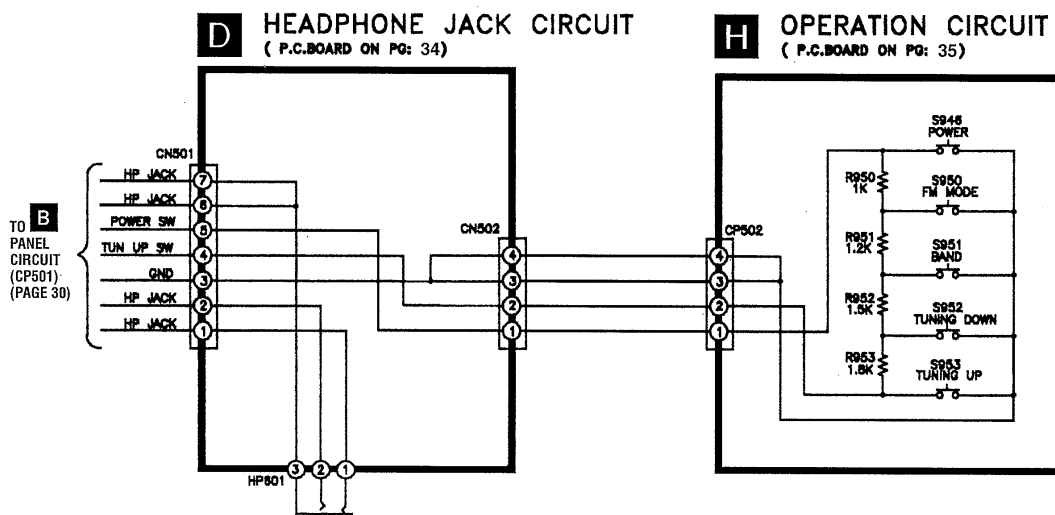

**A** TUNER CIRCUIT For (EG) area (P.C.BOARD ON PG. 36)

⇨ : FM OSC Signal Line  
⇨ : FM Signal Line

⇨ : AM OSC Signal Line  
⇨ : AM Signal Line

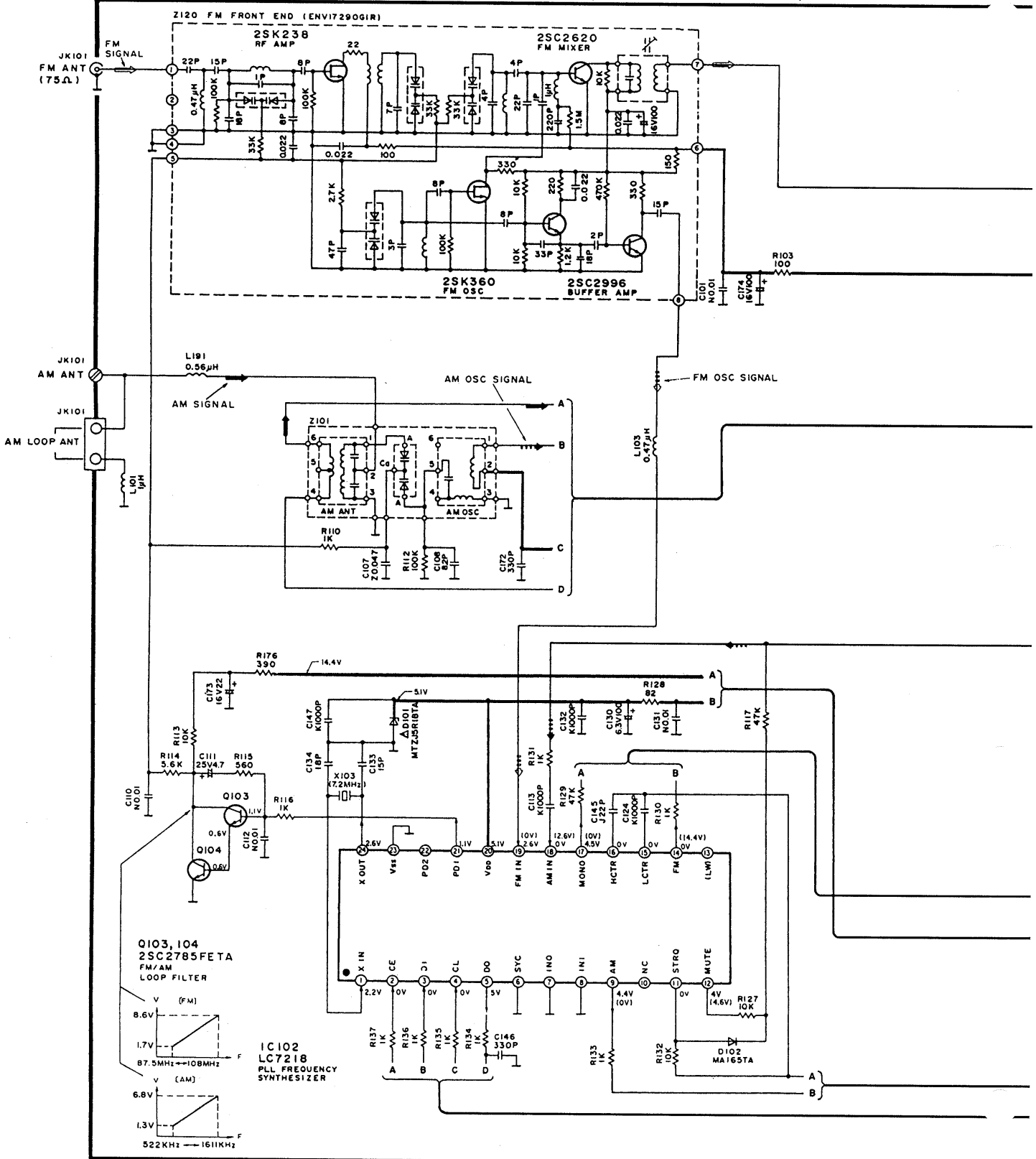



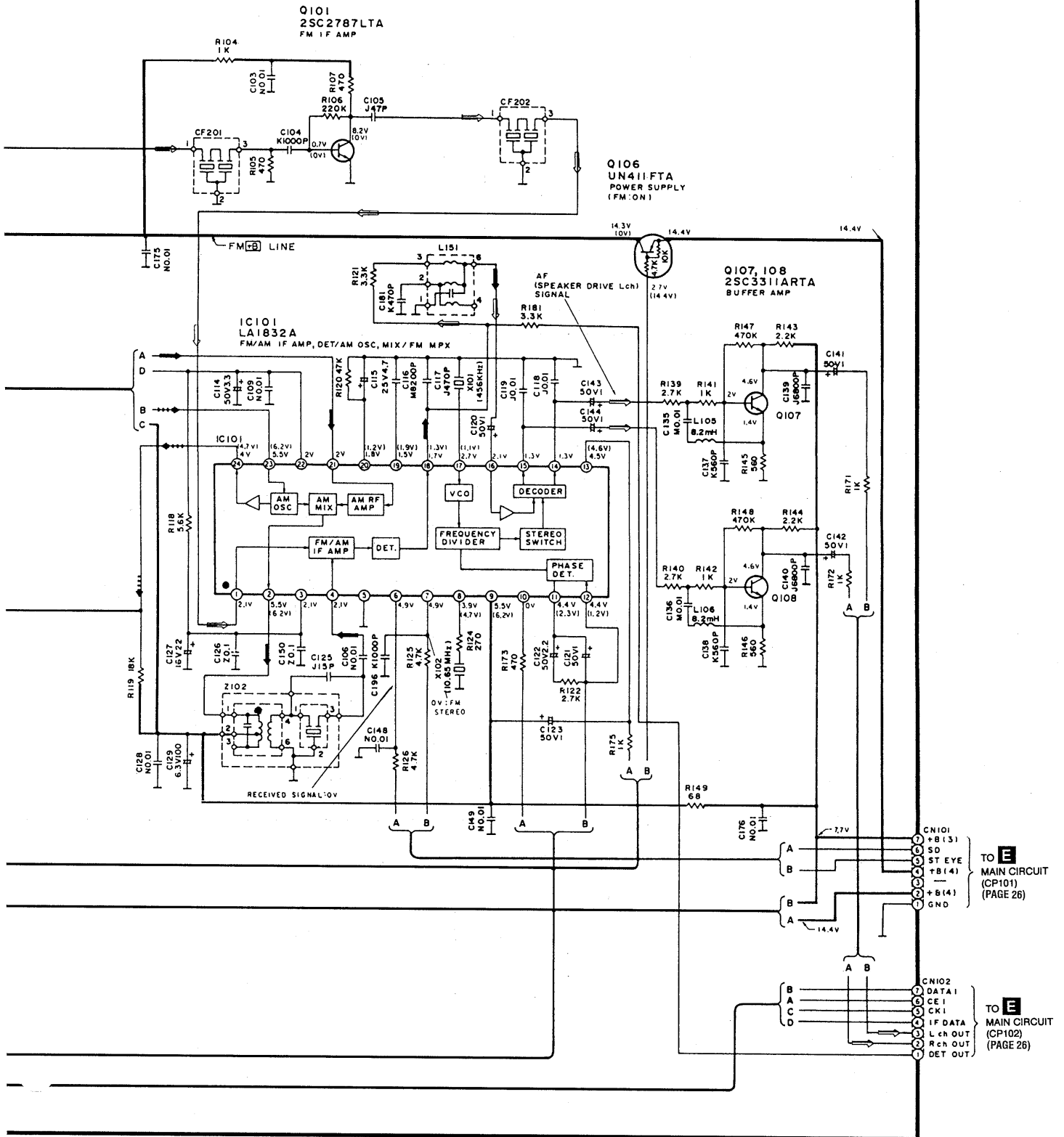

**E MAIN CIRCUIT** (P.C. BOARD ON PG.32)

⇨ : Main Signal Line ⇨ : FM/AM Signal Line

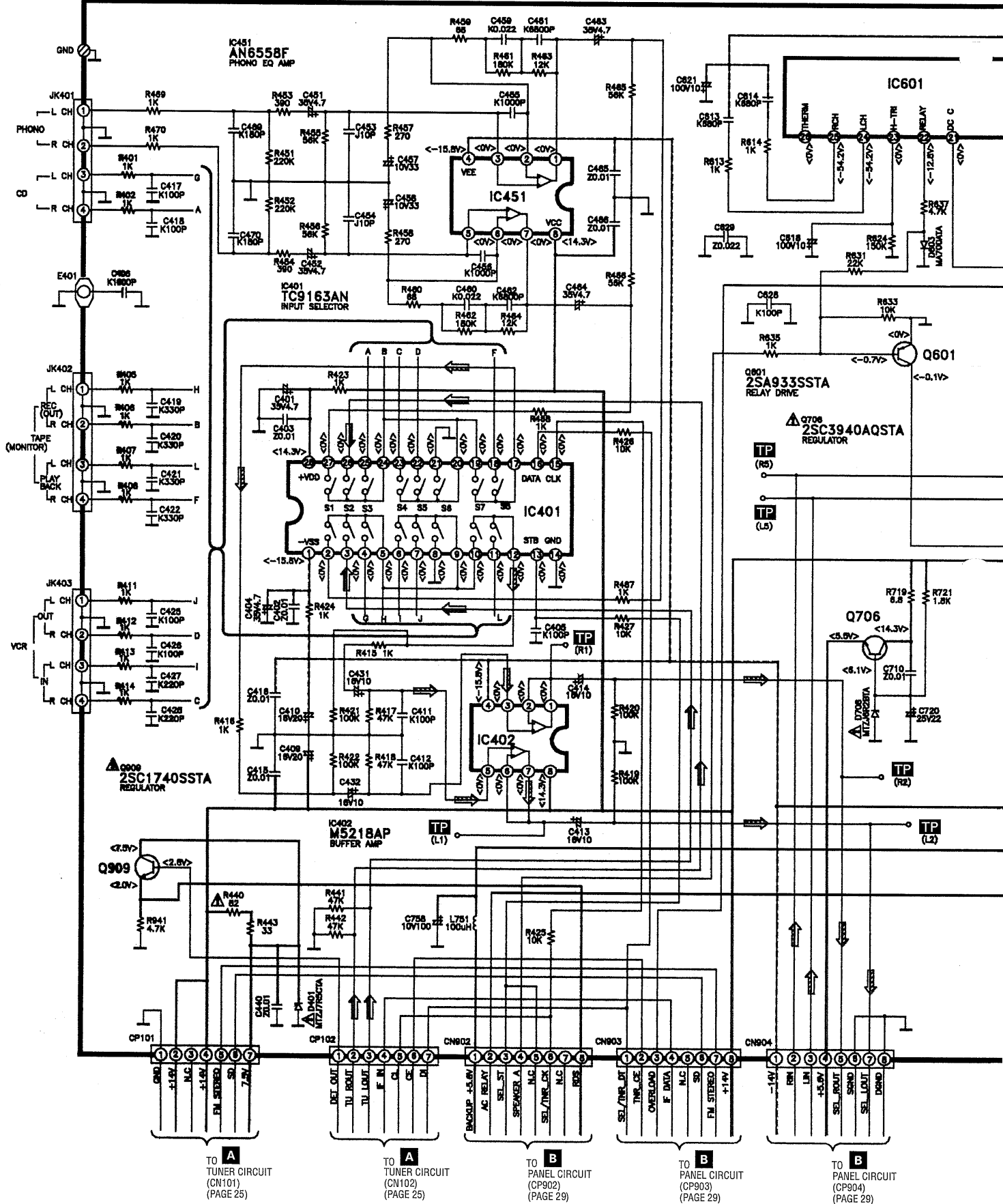

TO **A** TUNER CIRCUIT (CN101) (PAGE 25)

TO **A** TUNER CIRCUIT (CN102) (PAGE 25)

TO **B** PANEL CIRCUIT (CN902) (PAGE 29)

TO **B** PANEL CIRCUIT (CN903) (PAGE 29)

TO **B** PANEL CIRCUIT (CN904) (PAGE 29)

⇨ : Main Signal Line

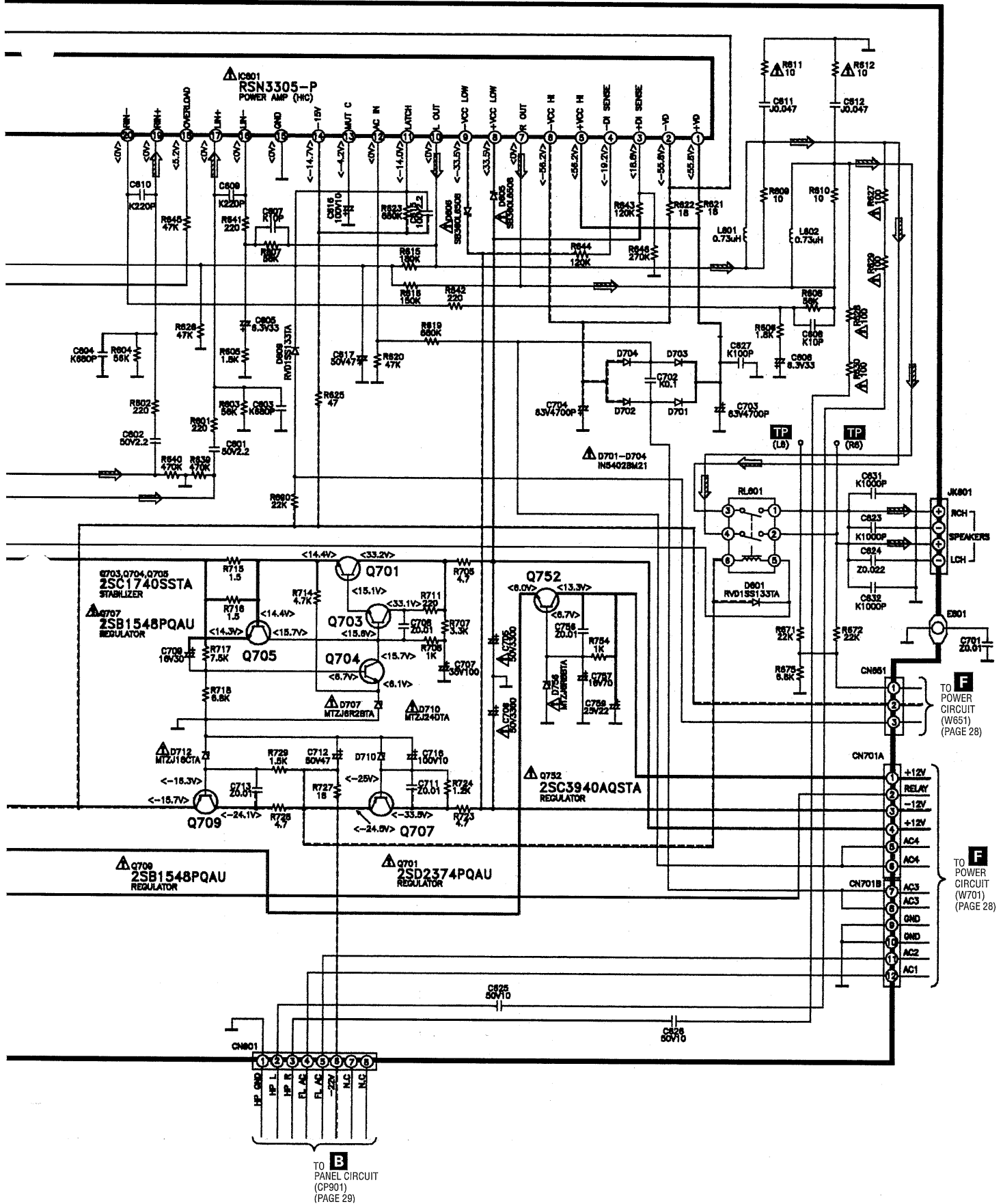

**B**  
TO PANEL CIRCUIT  
(CP901)  
(PAGE 29)

**F**  
TO POWER CIRCUIT  
(W651)  
(PAGE 28)

**F**  
TO POWER CIRCUIT  
(W701)  
(PAGE 28)

**F POWER CIRCUIT** (P.C. BOARD ON PG:37)

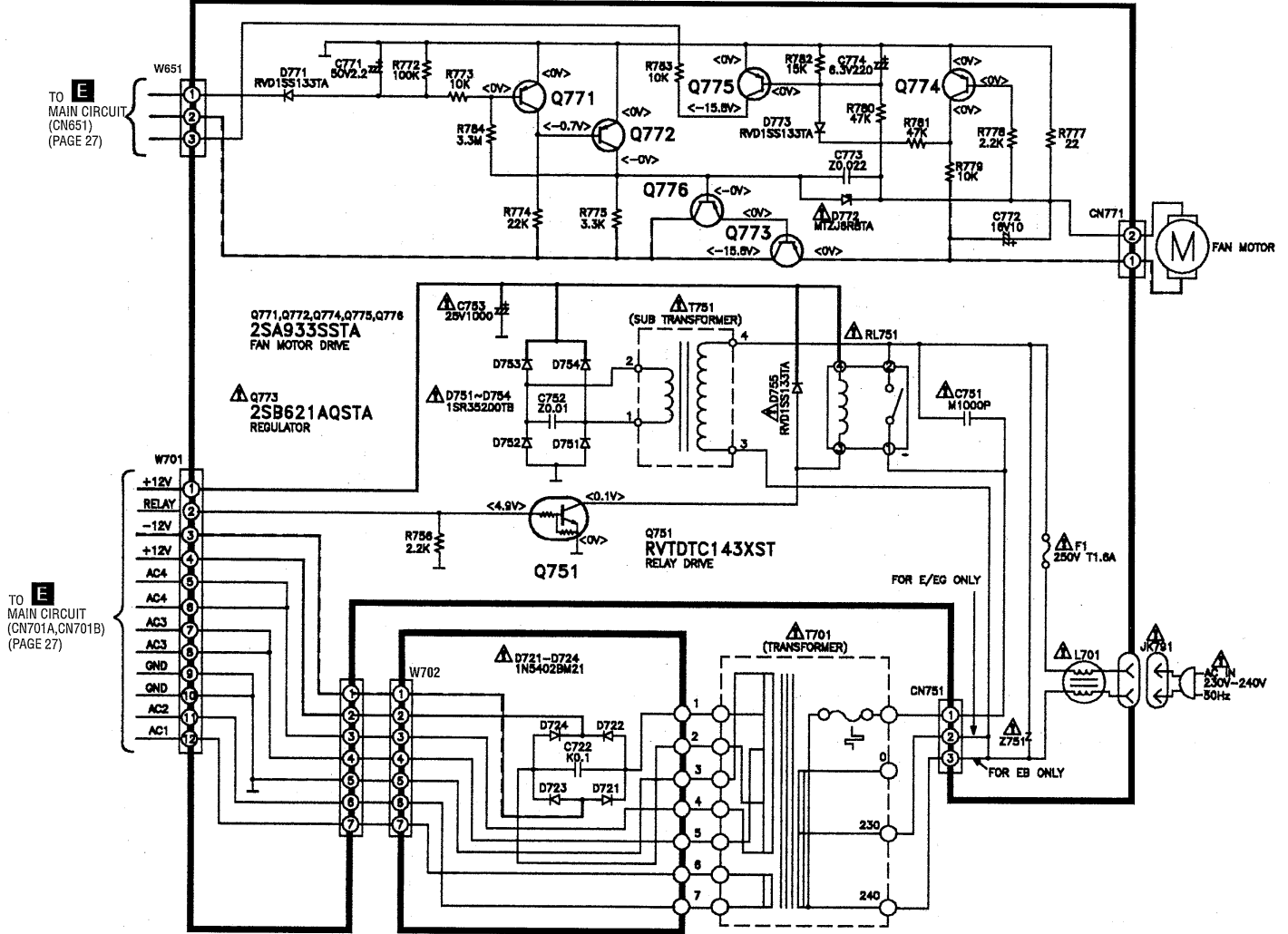

**G TRANSFORMER CIRCUIT**

(P.C. BOARD ON PG:37)

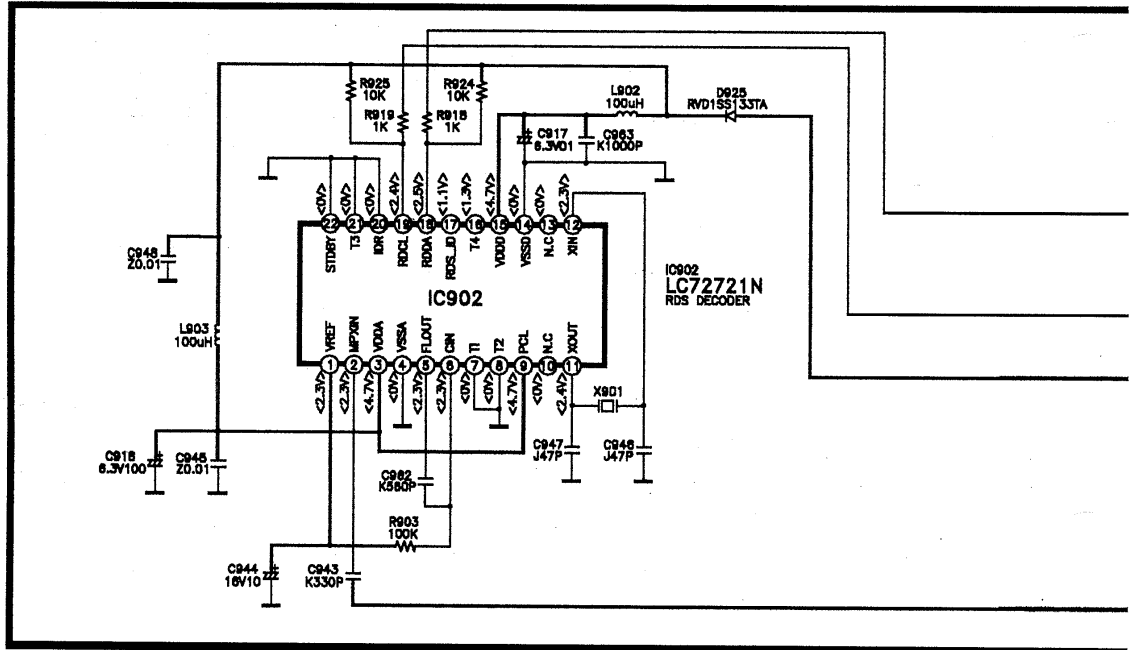

**B** PANEL CIRCUIT (P.C. BOARD ON PG 34)

→ : Main Signal Line

TO MAIN CIRCUIT (CN901) (PAGE 27)

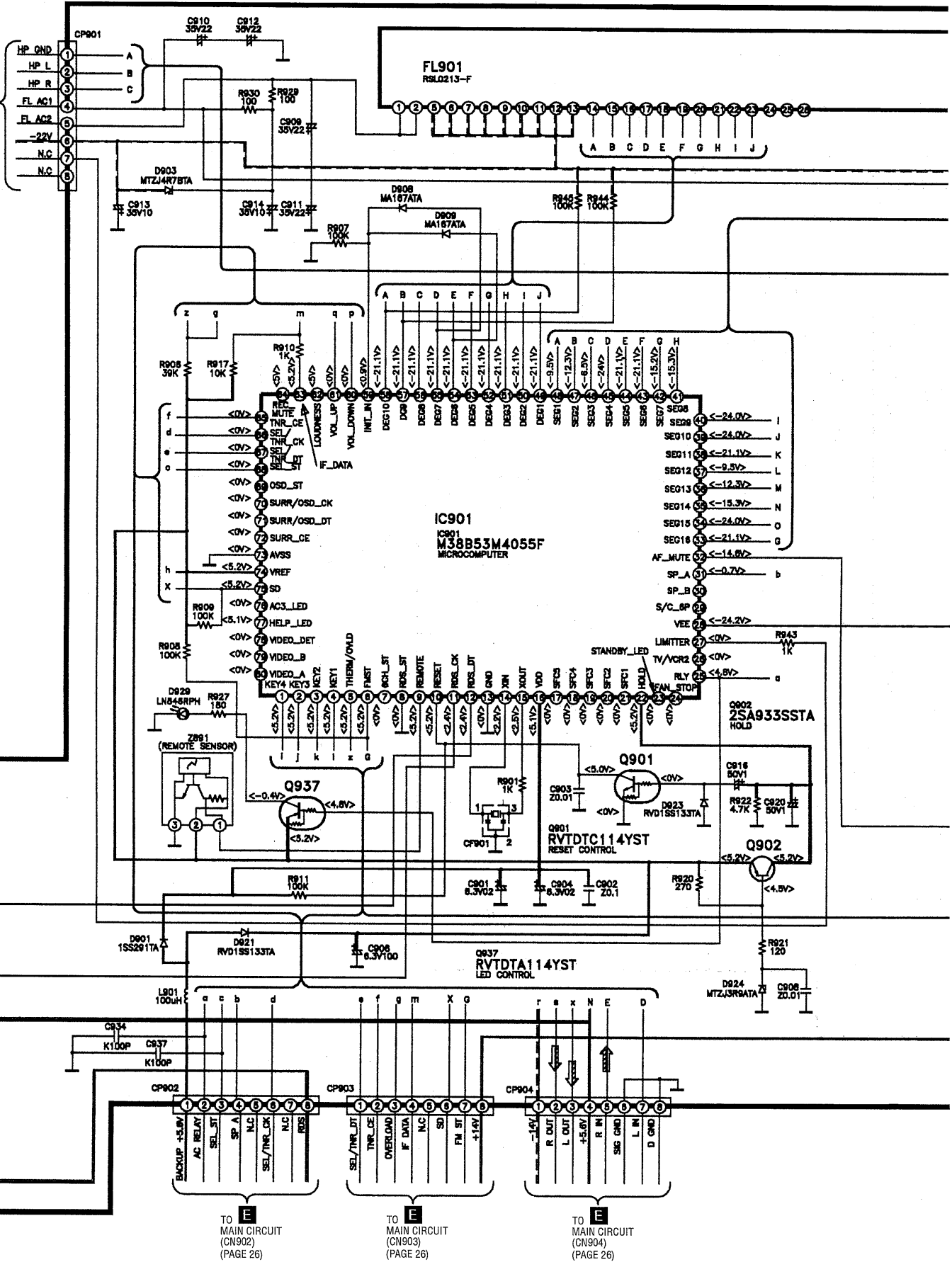

TO MAIN CIRCUIT (CN902) (PAGE 26)

TO MAIN CIRCUIT (CN903) (PAGE 26)

TO MAIN CIRCUIT (CN904) (PAGE 26)

→ : Main Signal Line

**C** VOLUME CIRCUIT  
(P.C. BOARD ON PG.34)

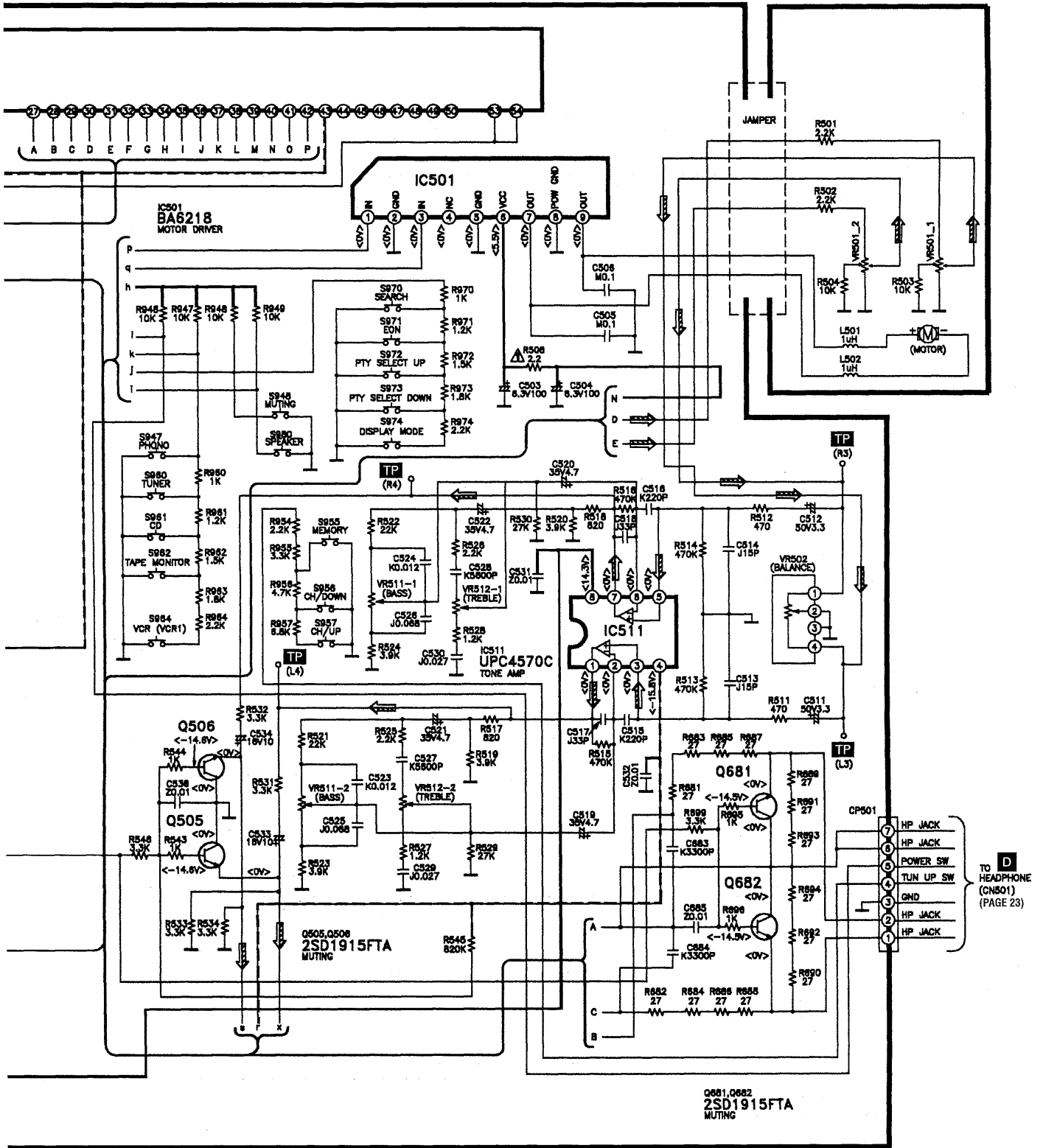

# Wiring Connection Diagram

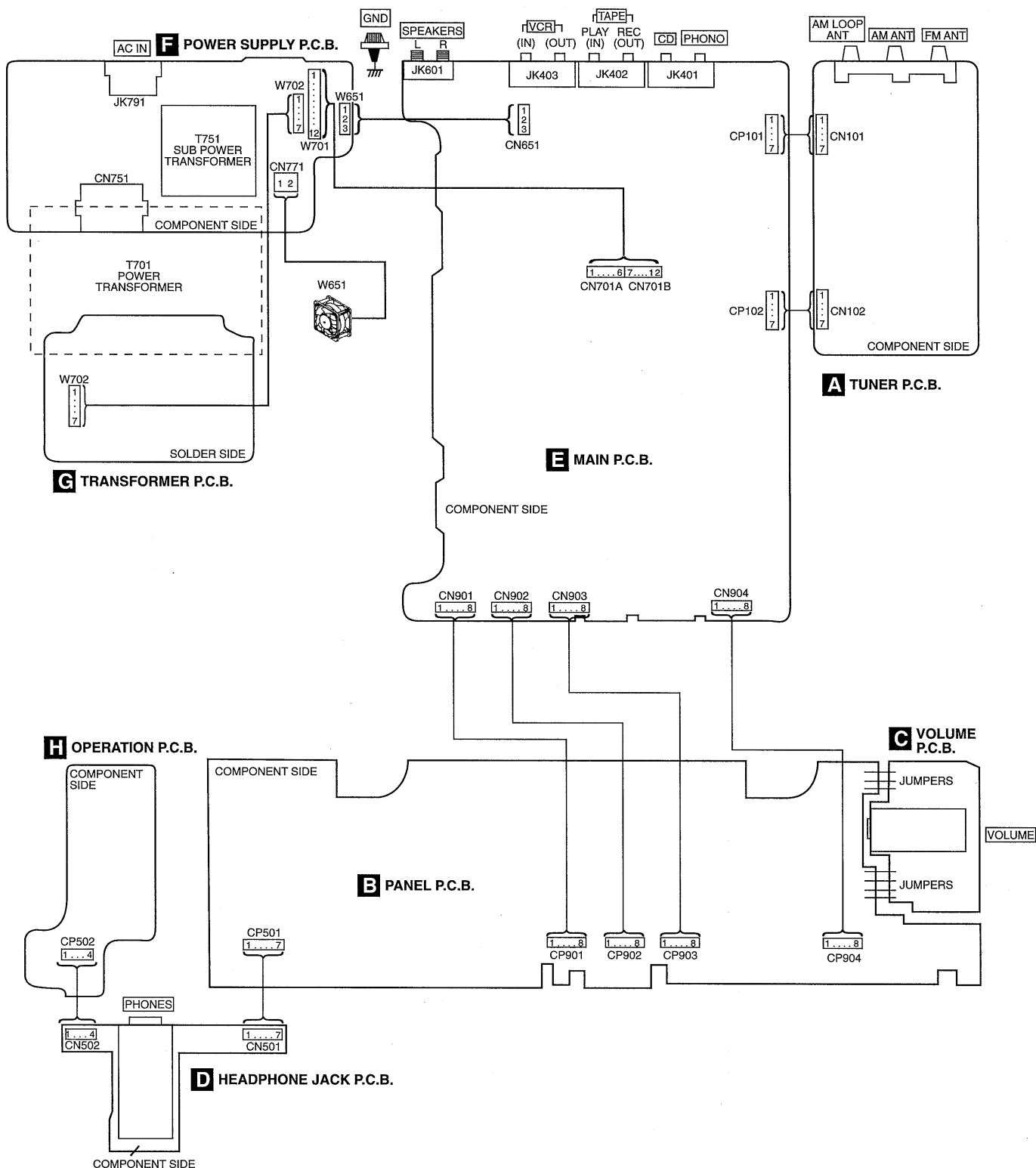

Printed Circuit Board

**E** MAIN P.C.B. (REP2251E-M)

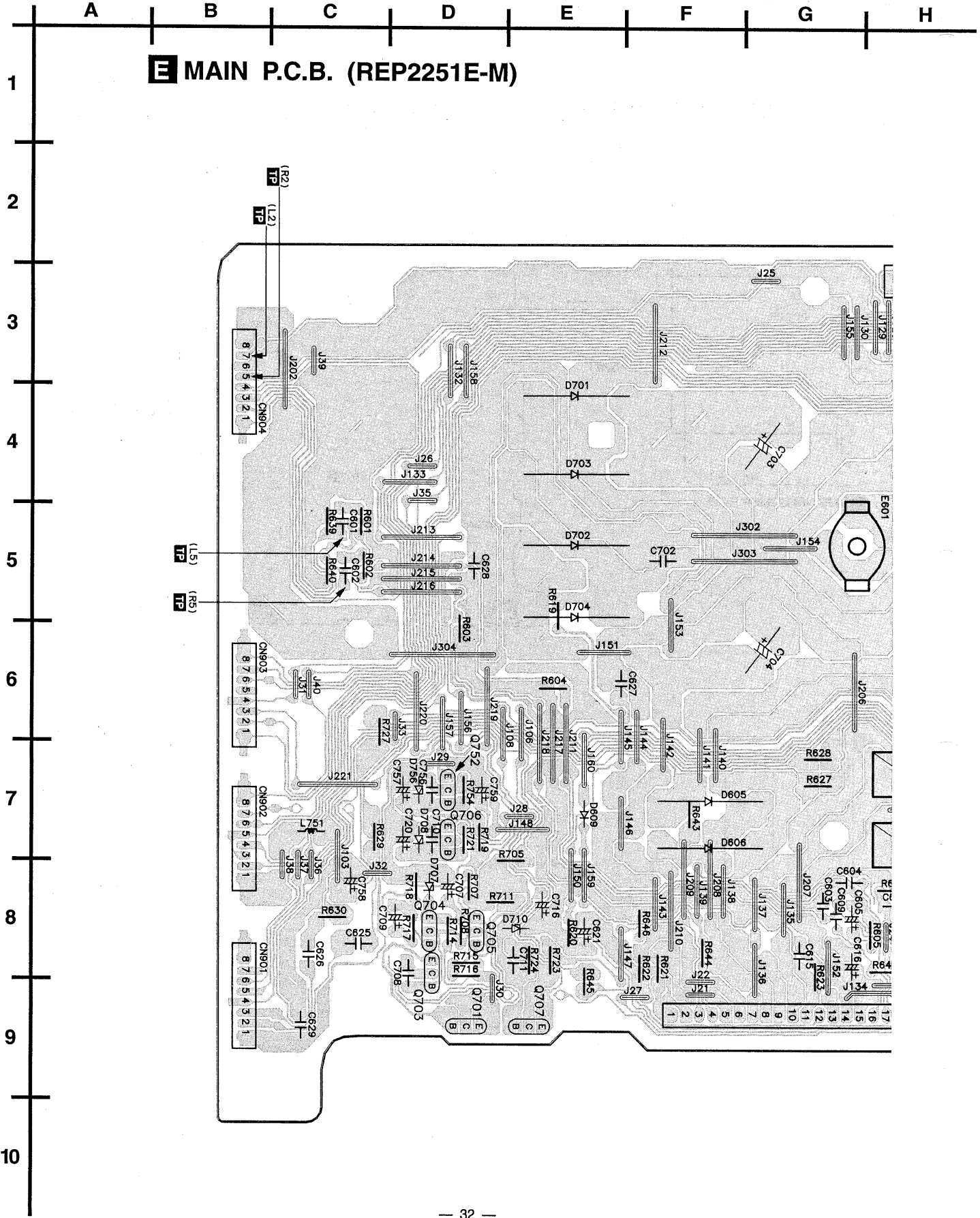



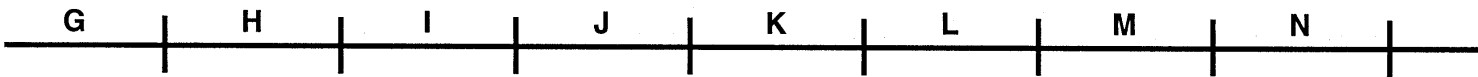

Parts Location Table

Ref No.	Loc No.
CN651	L8
CN701A	I6
CN701B	I5
CN901	B9
CN902	B7
CN903	B6
CN904	B4
CP101	L3
CP102	H3
D401	K3
D601	J7
D603	J7
D605	F7
D606	F7
D609	E7
D701	F4
D702	E5
D703	E4
D704	E5
D707	D8
D708	D7
D710	E8
D712	J8
D756	D7
E401	L4
E601	G5
IC401	K5
IC402	J5
IC601	K4
IC451	H9
JK401	M4
JK402	M5
JK403	M7
JK601	M9
L601	H7
L602	H7
L751	C7
Q601	J7
Q701	D9
Q703	D8
Q704	D8
Q705	D8
Q706	D7
Q707	E9
Q709	K9
Q752	D7
Q909	I3
RL601	J7

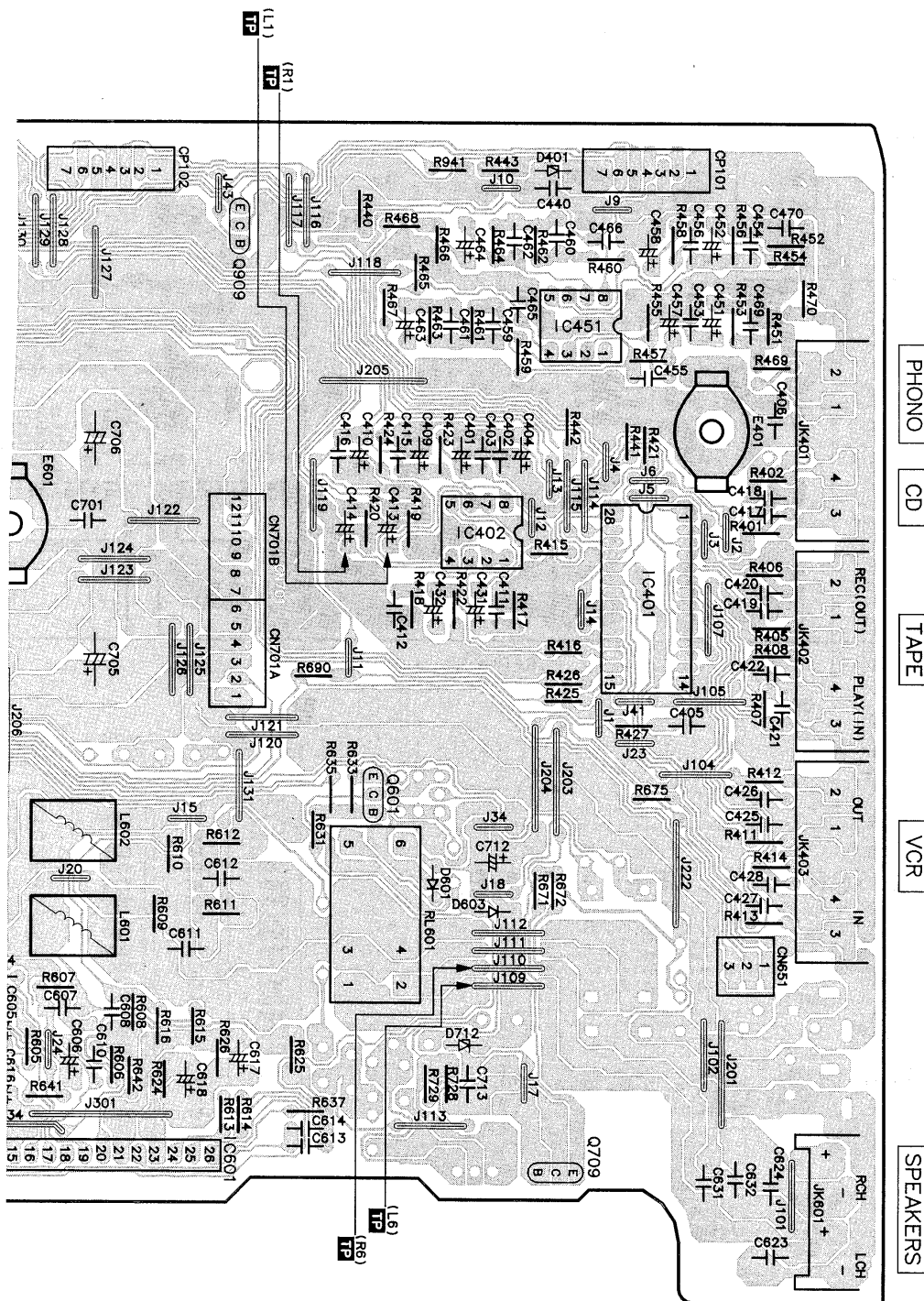

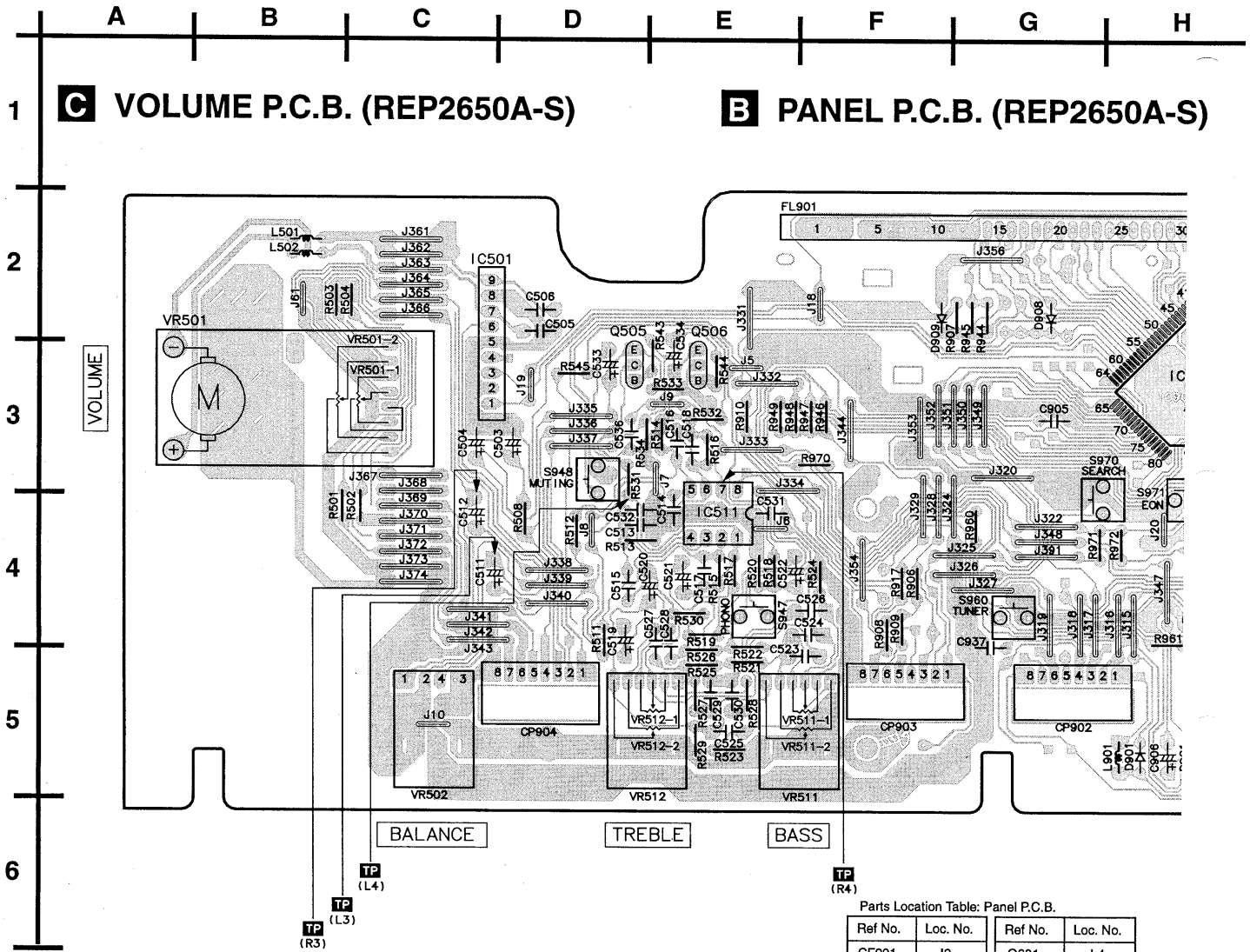

**D HEADPHONE JACK P.C.B. (REP2650A-S)**

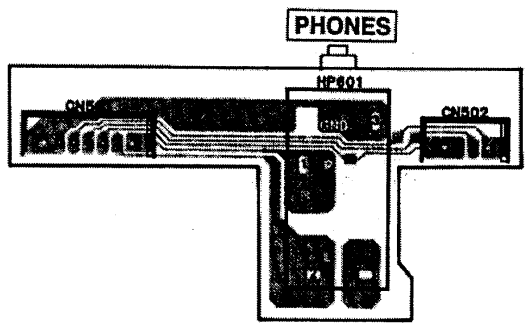

Parts Location Table: Panel P.C.B.

Ref No.	Loc. No.	Ref No.	Loc. No.
CF901	I3	Q681	L4
CP901	I5	Q682	L4
CP501	N5	Q901	M3
CP902	G5	Q902	L3
CP903	F5	Q937	K2
CP904	D5	S947	E4
D901	H5	S948	D3
D903	M2	S955	N2
D908	G2	S956	N3
D909	F2	S957	M3
D921	H5	S960	G4
D923	L2	S961	I4
D924	L3	S962	J4
D925	K5	S964	L4
D929	K2	S970	G3
FL901	F2	S971	H3
IC501	C2	S972	I3
IC511	E4	S973	I3
IC901	H3	S974	J3
IC902	L5	S980	N5
L501	B2	X901	K5
L502	B2	VR501	B3
L901	H5	VR502	C5
L902	K5	VR511	E5
L903	M5	VR512	D5
Q505	D3	Z891	L2
Q506	E3		

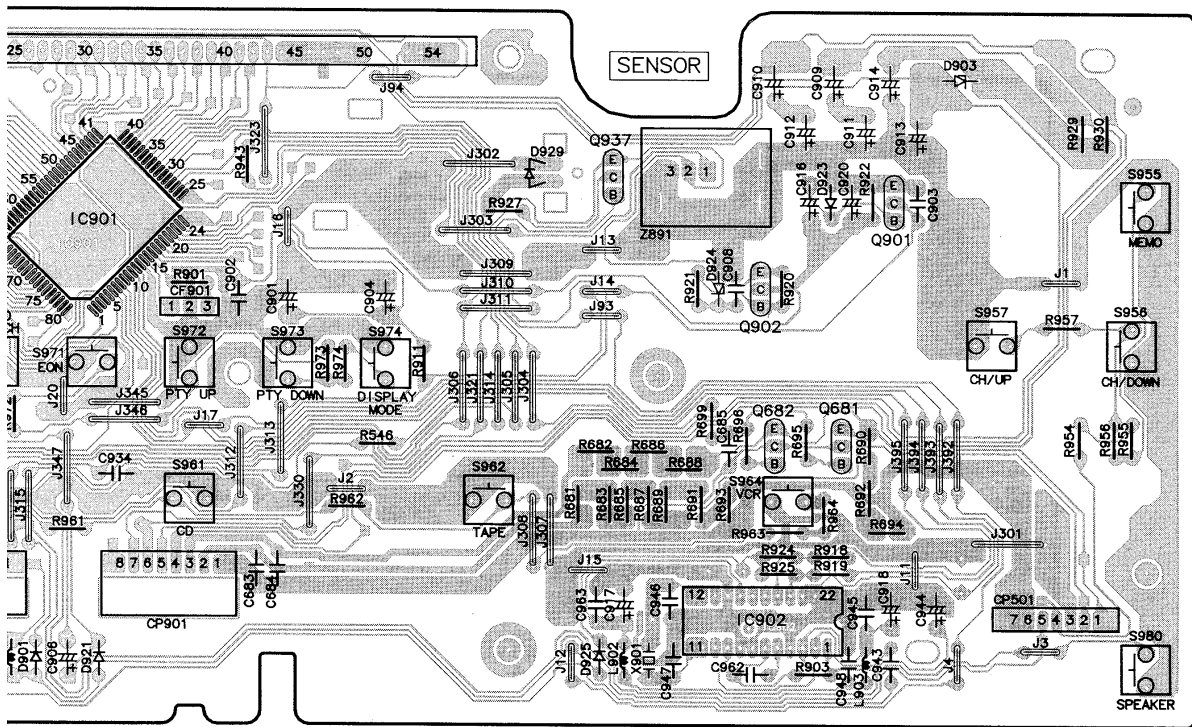

**H OPERATION P.C.B. (REP2650A-S)**

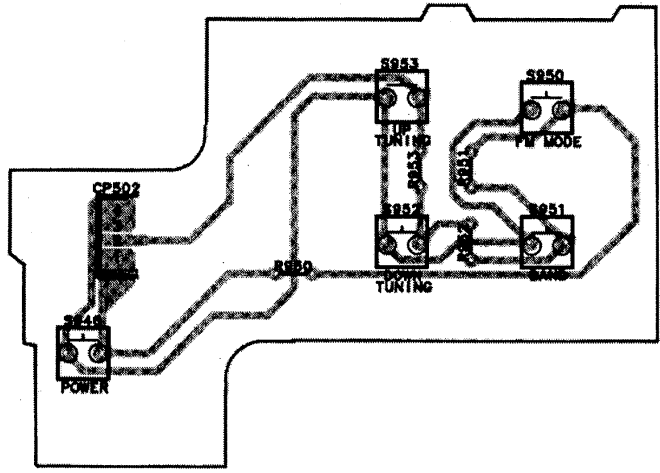

**A** TUNER P.C.B. (REP2158A-T ..EG)  
(REP2158D-T ..E,EB)

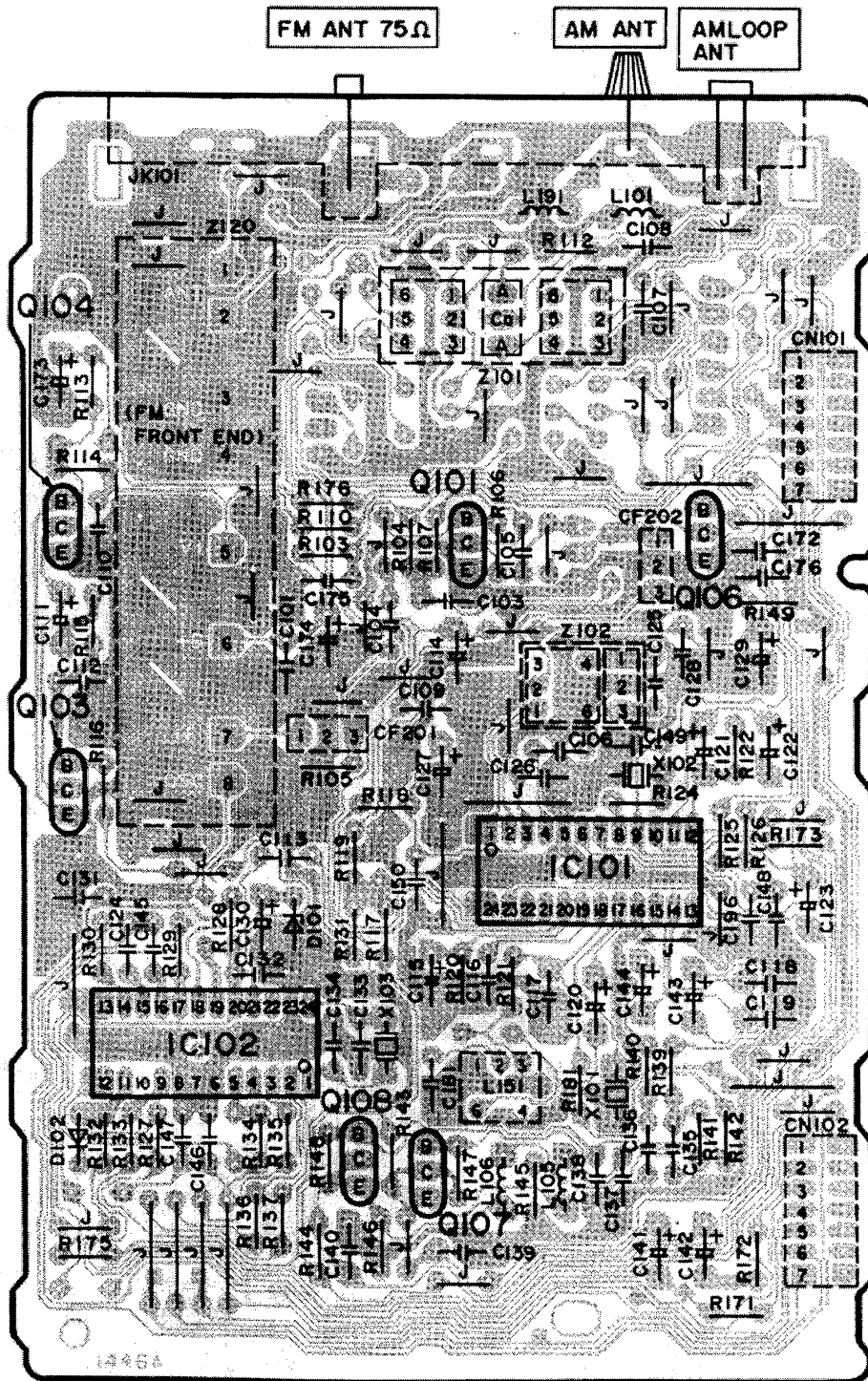

**G** TRANSFORMER P.C.B. (REP2675A-P ..E,EG)

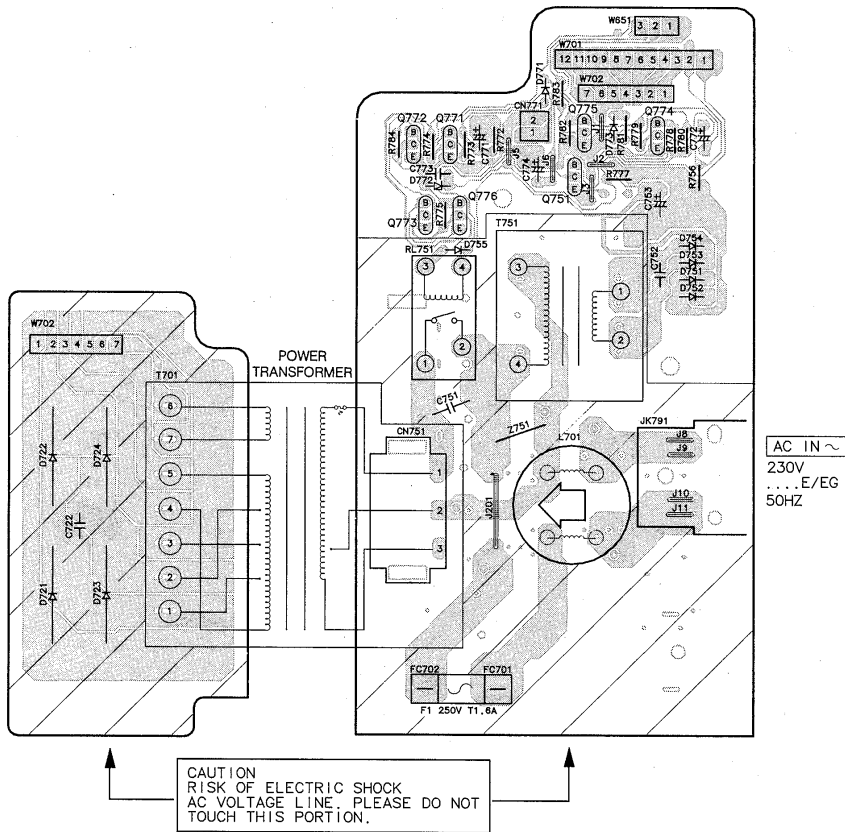

**F** POWER SUPPLY P.C.B. (REP2675A-P ..E,EG)

AC IN ~  
230V  
...E/EG  
50HZ

**G** TRANSFORMER P.C.B. (REP2675B-P ..EB)

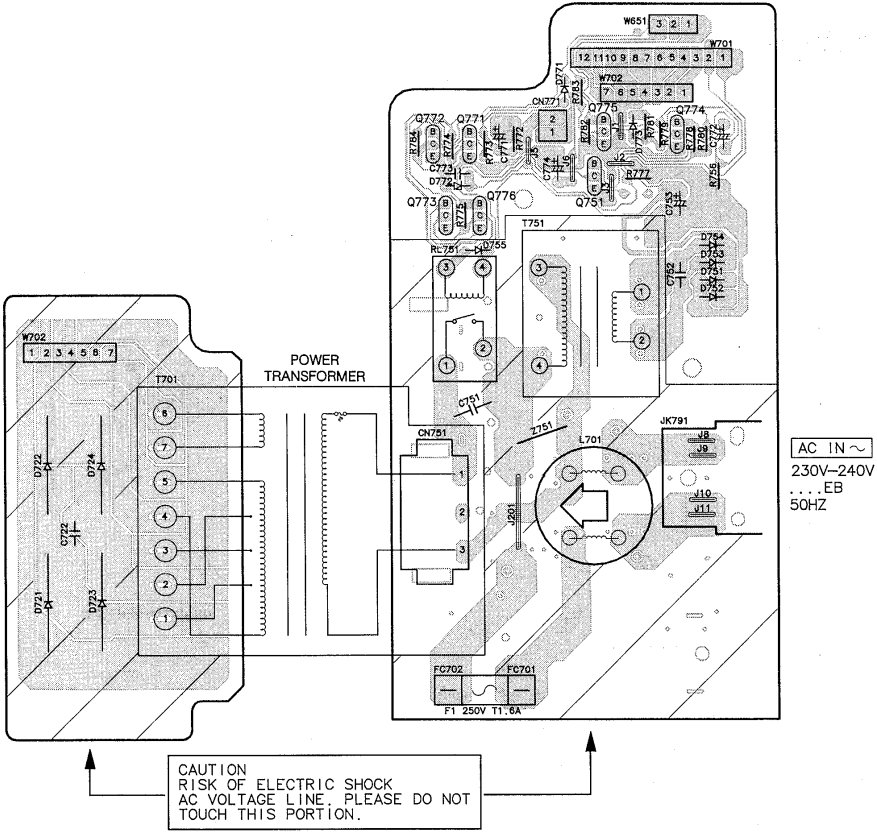

AC IN ~  
230V-240V  
...EB  
50HZ

**F** POWER SUPPLY P.C.B. (REP2675B-P ..EB)

# Cabinet Parts Location

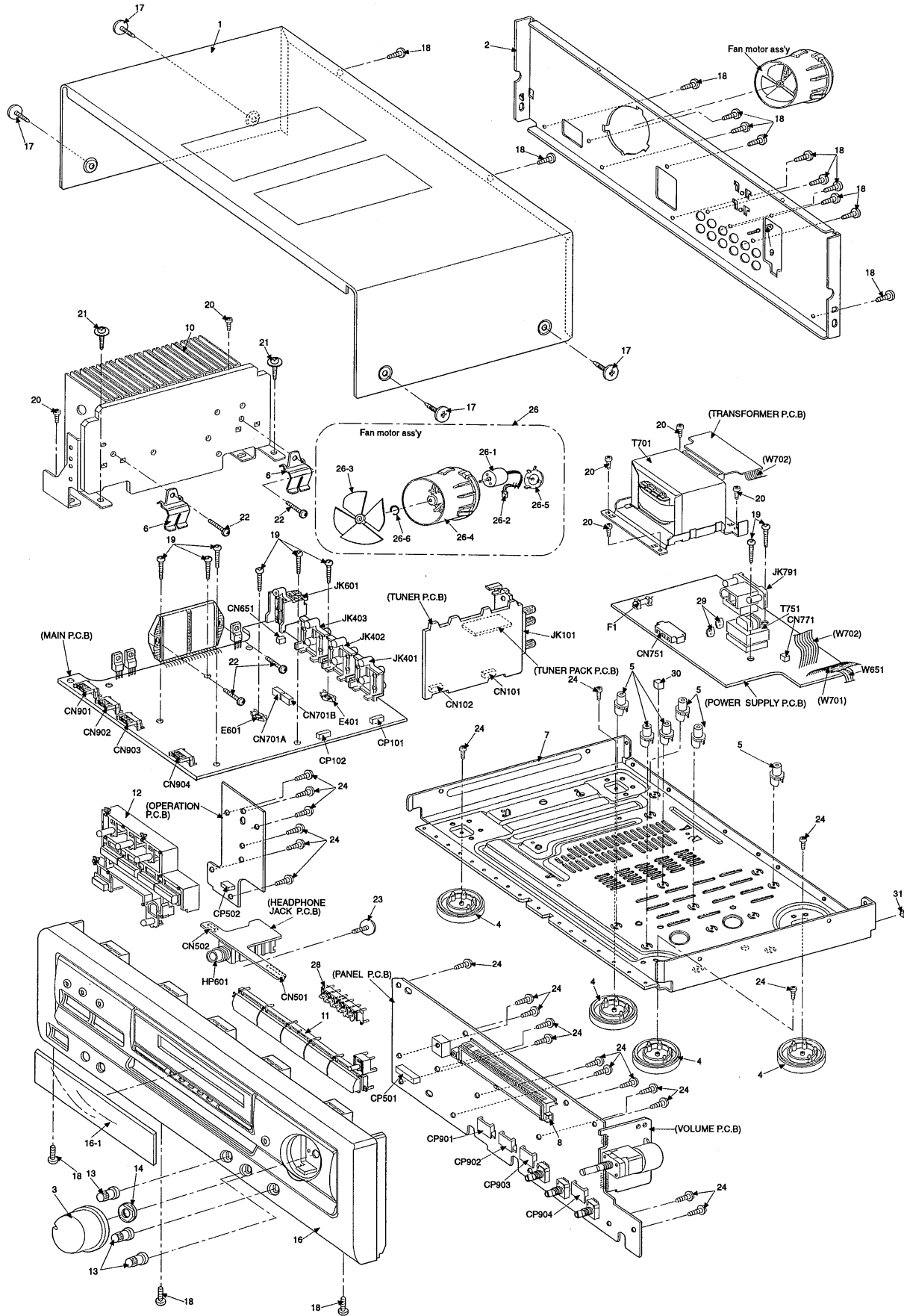



## Replacement Parts List

Notes : \* Important safety notice:  
 Components identified by  $\triangle$  mark have special characteristics important for safety.  
 Furthermore, special parts which have purposes of fire-retardant (resistors), high-quality sound (capacitors), low-noise (resistors), etc. are used.  
 When replacing any of components, be sure to use only manufacturer's specified parts shown in the parts list.  
 \* The parenthesized in the Remarks columns specify the areas. (Refer to the cover page for area.)  
 Parts without these indication can be used for all areas.  
 \* [M] in Remarks column indicates parts that are supplied by MESA.

Ref No.	Part No.	Part Name & Description	Remarks	Ref No.	Part No.	Part Name & Description	Remarks	Ref No.	Part No.	Part Name & Description	Remarks
		<b>CABINET AND CHASSIS</b>				<b>INTEGRATED CIRCUITS</b>		Q775	2SA933SSTA	TRANSISTOR	[M]
1	RKM0374B-K	TOP CABINET	[M]	IC101	LA1832A	IC, IF/MPX	[M]	Q776	2SA933SSTA	TRANSISTOR	[M]
2	RGR0178F-E	REAR PANEL	[M]EG E	IC102	LC7218	IC, PLL	[M]	Q901	RVTDTTC114YST	TRANSISTOR	[M]
2	RGR0178F-F	REAR PANEL	[M]EB	IC401	TC9163AN	IC, SELECTOR	[M]	Q902	2SA933SSTA	TRANSISTOR	[M]
3	RGW0243A-K	VOLUME KNOB	[M]	IC402	M5218AP	IC, BUFFER AMP	[M]	Q909	2SC1740SSTA	TRANSISTOR $\triangle$	[M]
4	RKA0079-A	FOOT	[M]	IC451	AN6558F	IC, OP AMP	[M]	Q937	RVTDTA114YST	TRANSISTOR	[M]
5	RKQ0089-J	PCB HOLDER	[M]	IC501	BA6218	IC, MOTOR DRIVER	[M]			<b>DIODES</b>	
6	RMC0158-S	TRANSISTOR HOLDER	[M]	IC511	UPC4570C	IC, TONE CONTROL	[M]	D101	MTZJ5R1BTA	DIODE	[M]
7	RMK0276	BOTTOM CHASSIS	[M]	IC601	RSN3305-P	IC, HIC $\triangle$	[M]	D102	MA165TA	DIODE	[M]
8	RMN0372	FL HOLDER	[M]	IC901	M38B53M4055F	IC, MICOM	[M]	D401	MTZJ7R5CTA	DIODE	[M]
9	SNE2123	EARTH TERMINAL	[M]	IC902	LC72721N	IC, RDS	[M]	D601	RVD1SS133TA	DIODE	[M]
10	RXX0169	HEAT SINK UNIT	[M]			<b>TRANSISTORS</b>		D603	MA700ATA	DIODE	[M]
11	RGU1349-K	SELECTOR BUTTON	[M]	Q101	2SC2787LTA	TRANSISTOR	[M]	D605	SB360L6508	DIODE $\triangle$	[M]
12	RGU1350-K	MODE BUTTON	[M]	Q103	2SC2785FETA	TRANSISTOR	[M]	D606	SB360L6508	DIODE $\triangle$	[M]
13	RGW0244-K	BASS TREBLE KNOB	[M]	Q104	2SC2785FETA	TRANSISTOR	[M]	D609	RVD1SS133TA	DIODE	[M]
14	RHN90001	M9 NUT	[M]	Q106	RVTDTA143XST	TRANSISTOR	[M]	D701	1N5402BM21	DIODE $\triangle$	[M]
16	RFKGEX120EBK	FRONT PANEL ASSY	[M]	Q107	2SC3311ARTA	TRANSISTOR	[M]	D702	1N5402BM21	DIODE $\triangle$	[M]
16-1	RKW0436A-Q	WINDOW	[M]	Q108	2SC3311ARTA	TRANSISTOR	[M]	D703	1N5402BM21	DIODE $\triangle$	[M]
17	SNE2129-1	SCREW (CABINET)	[M]	Q108	2SC3311ARTA	TRANSISTOR	[M]	D704	1N5402BM21	DIODE $\triangle$	[M]
18	XTBS3+8JFZ1	SCREW	[M]	Q505	2SD1915FTA	TRANSISTOR	[M]	D707	MTZJ6R2BTA	DIODE $\triangle$	[M]
19	XTB3+20JFZ	SCREW	[M]	Q506	2SD1915FTA	TRANSISTOR	[M]	D708	MTZJ6R2BTA	DIODE $\triangle$	[M]
20	XTB3+8FFZ	SCREW	[M]	Q601	2SA933SSTA	TRANSISTOR	[M]	D710	MTZJ24DTA	DIODE $\triangle$	[M]
21	XTWS3+8T	SCREW	[M]	Q681	2SD1915FTA	TRANSISTOR	[M]	D712	MTZJ16CTA	DIODE $\triangle$	[M]
22	XTW3+15T	SCREW	[M]	Q682	2SD1915FTA	TRANSISTOR	[M]	D721	1N5402BM21	DIODE $\triangle$	[M]
23	RHD26016	SCREW	[M]	Q701	2SD2374PQAU	TRANSISTOR $\triangle$	[M]	D722	1N5402BM21	DIODE $\triangle$	[M]
24	XTBS26+10J	SCREW	[M]	Q703	2SC1740SSTA	TRANSISTOR	[M]	D723	1N5402BM21	DIODE $\triangle$	[M]
26	RYQ0173-K	FAN UNIT	[M]	Q704	2SC1740SSTA	TRANSISTOR	[M]	D724	1N5402BM21	DIODE $\triangle$	[M]
26-1	MDN-4RB4MRC	MOTOR	[M]	Q705	2SC1740SSTA	TRANSISTOR	[M]	D751	1SR35200TB	DIODE $\triangle$	[M]
26-2	REX0811	CONNECTOR UNIT	[M]	Q706	2SC3940AQSTA	TRANSISTOR $\triangle$	[M]	D752	1SR35200TB	DIODE $\triangle$	[M]
26-3	SHE232-1	64MM PROPELLER	[M]	Q707	2SB1548PQAU	TRANSISTOR $\triangle$	[M]	D753	1SR35200TB	DIODE $\triangle$	[M]
26-4	SHE233-1	FAN CASE	[M]	Q709	2SB1548PQAU	TRANSISTOR $\triangle$	[M]	D754	1SR35200TB	DIODE $\triangle$	[M]
26-5	SHE234	FAN CASE COVER	[M]	Q751	RVTDTTC143XST	TRANSISTOR	[M]	D755	RVD1SS133TA	DIODE $\triangle$	[M]
26-6	SUS271	MOTOR SPRING	[M]	Q752	2SC3940AQSTA	TRANSISTOR $\triangle$	[M]	D756	MTZJ6R8BTA	DIODE $\triangle$	[M]
28	RGU1352D-K	DOLBY BUTTON	[M]	Q771	2SA933SSTA	TRANSISTOR	[M]	D771	RVD1SS133TA	DIODE	[M]
29	RMZ0339	ZNR COVER	[M]	Q772	2SA933SSTA	TRANSISTOR	[M]	D772	MTZJ6R8BTA	DIODE $\triangle$	[M]
30	RKQ0213-K	PCB SUPPORT	[M]	Q773	2SB621AQSTA	TRANSISTOR $\triangle$	[M]	D773	RVD1SS133TA	DIODE	[M]
31	RMQ0670	ADJUSTER SPACER	[M]	Q774	2SA933SSTA	TRANSISTOR	[M]	D901	1SS291TA	DIODE	[M]





Ref No.	Part No.	Part Name & Description	Remarks	Ref No.	Part No.	Part Name & Description	Remarks	Ref No.	Part No.	Part Name & Description	Remarks
D903	MTZJ4R7BTA	DIODE	[M]	CN751	SJS305-1	3P CONNECTOR	[M]	CF901	RVCBST4R00MT	CERAMIC OSCILLATOR	[M]
D908	MA167ATA	DIODE	[M]	CN771	SJT3213	FAN CONNECTOR	[M]				
D909	MA167ATA	DIODE	[M]	CN901	RJU003K008M1	BOAD IN CONNECTOR	[M]			<b>RELAYS</b>	
D921	RVD1SS133TA	DIODE	[M]	CN902	RJU003K008M1	BOAD IN CONNECTOR	[M]				
D923	RVD1SS133TA	DIODE	[M]	CN903	RJU003K008M1	BOAD IN CONNECTOR	[M]	RL601	RSY0013M-0	RELAY	[M]
D924	MTZJ3R9ATA	DIODE	[M]	CN904	RJU003K008M1	BOAD IN CONNECTOR	[M]	RL751	RSY0019M-0	12V TV-5 RELAY	[M] ⚠
D925	RVD1SS133TA	DIODE	[M]	CP101	RJT057W007-1	7P CONNECTOR	[M]				
D929	LN846RPH	DIODE	[M]	CP102	RJT057W007-1	7P CONNECTOR	[M]			<b>OSCILLATORS</b>	
				CP501	RJT100W07	7P CONNECTOR	[M]				
		<b>VARIABLE RESISTORS</b>		CP502	RJT100W04	4P CONNECTOR	[M]	X101	RSXZ456KM07M	CERAMIC OSCILLATOR	[M]
				CP901	RJT003K008M1	8P CONNECTOR	[M]	X102	RLFDGTD01I	FM RESONATOR	[M]
VR501	EUWMGB026B15	VR, MOTOR VOLUME	[M]	CP902	RJT003K008M1	8P CONNECTOR	[M]	X103	SVQ49U722T-S	CRYSTAL 7.2MHZ	[M]
VR502	EVJ02QF01G15	VR, BALANCE CONTROL	[M]	CP903	RJT003K008M1	8P CONNECTOR	[M]	X901	RSXC4M33S02T	CRYSTAL 4.33 MHZ	[M]
VR511	EVJYA1F01C15	VR, TONE CONTROL	[M]	CP904	RJT003K008M1	8P CONNECTOR	[M]				
VR512	EVJYA1F01C15	VR, TONE CONTROL	[M]							<b>DISPLAY TUBE</b>	
		<b>SWITCHES</b>									
				L101	ELESN1R0MA	CHOKE COIL	[M]	FL901	RSL0233-F	FL	[M]
S946	EVQ21405R	SW, POWER	[M]	L103	ELESTR47MA9	CHOKE COIL	[M]			<b>FUSES</b>	
S947	EVQ21405R	SW, PHONO	[M]	L105	RLQZB822KT-D	TAPING COIL	[M]				
S948	EVQ21405R	SW, MUTING	[M]	L106	RLQZB822KT-D	TAPING COIL	[M]	F1	XBA2C16TB0	FUSE	[M] ⚠
S950	EVQ21405R	SW, FM MODE	[M]	L151	SLM1B10-1M	A.B. FILTER	[M]				
S951	EVQ21405R	SW, BAND	[M]	L191	ELESNR56MA	CHOKE COIL	[M]			<b>FUSE HOLDERS</b>	
S952	EVQ21405R	SW, TUNING DOWN	[M]	L501	RLQZP1R0KT-Y	AXIAL COIL	[M]				
S953	EVQ21405R	SW, TUNING	[M]	L502	RLQZP1R0KT-Y	AXIAL COIL	[M]	FC701	RJR0169T	FUSE HOLDER	[M]
S955	EVQ21405R	SW, MEMO	[M]	L601	RLQYR73MW-E	CHOKE COIL	[M]	FC702	RJR0169T	FUSE HOLDER	[M]
S956	EVQ21405R	SW, CH/DOWN	[M]	L602	RLQYR73MW-E	CHOKE COIL	[M]				
S957	EVQ21405R	SW, CH/UP	[M]	L701	SLQZ650MH49	AC LINE COIL	[M] ⚠			<b>JACKS</b>	
S960	EVQ21405R	SW, TUNER	[M]	L751	ELESN101KA	CHOKE COIL	[M]				
S961	EVQ21405R	SW, CD	[M]	L901	RLQB101KTA-Y	CHOKE COIL	[M]	HP601	RJJ63TS01	JK, HEADPHONES	[M]
S962	EVQ21405R	SW, TAPE	[M]	L902	RLQZP101KT-Y	AXIAL COIL	[M]	JK101	RJH4202-1	JK, ANT TERMINAL	[M]
S964	EVQ21405R	SW, VCR	[M]	L903	RLQZP101KT-Y	AXIAL COIL	[M]	JK401	SJF3069N	JK, LINE	[M]
S970	EVQ21405R	SW, SEARCH	[M]	T701	RTP1N5B027-X	POWER TRANSFORMER	[M] ⚠	JK402	SJF3069N	JK, LINE	[M]
S971	EVQ21405R	SW, EON	[M]	T751	RTP15E003-V	SUB POWER TRANSFORMER	[M] ⚠	JK403	SJF3069N	JK, LINE	[M]
S972	EVQ21405R	SW, PTY SELECT UP	[M]					JK601	RJR0054	JK, SP TERMINAL	[M]
S973	EVQ21405R	SW, PTY SELECT DOWN	[M]					JK791	SJS9236-1	JK, AC INLET	[M] ⚠
S974	EVQ21405R	SW, DISPLAY MODE	[M]								
S980	EVQ21405R	SW, SPEAKER	[M]							<b>EARTH TERMINALS</b>	
				Z101	RLA2Z002M-T	AM ANT. COIL	[M]				
				Z102	RLI2Z006M-T	AM IFT	[M]	E401	SNE1004-2	EARTH TERMINAL	[M]
		<b>CONNECTORS</b>		Z120	ENV17290G1R	FM TUNER PACK	[M]JEG	E601	SNE1004-2	EARTH TERMINAL	[M]
				Z120	ENV17290G1Y	FM TUNER PACK	[M]JEB E				
CN101	RJU057W007	7P CONNECTOR	[M]	Z751	ERZV10V511CS	ZNR	[M] ⚠				
CN102	RJU057W007	7P CONNECTOR	[M]	Z891	RCDSPS4242N	REMOTE SENSOR	[M]			<b>WIRES</b>	
CN501	RJU100W07	7P CONNECTOR	[M]								
CN502	RJU100W04	4P CONNECTOR	[M]								
CN651	RJS1A6603T1	3P TAPING CONNECTOR	[M]								
CN701A	RJS1A6606T1	6P STAPING CONNECTOR	[M]								
CN701B	RJS1A6606T1	6P STAPING CONNECTOR	[M]								
										<b>CERAMIC FILTERS</b>	
				CF201	RLFFETNGD01L	CERAMIC CAPACITOR	[M]	W651	RWJ1803190CC	WIRE	[M]
				CF202	RLFFETMGD01L	CERAMIC FILTER	[M]	W701	RWJ1812300CC	WIRE	[M]
								W702	RWJ1807180CC	WIRE	[M]







## Resistors & Capacitors

Notes : \* Important safety notice:  
 Components identified by  $\triangle$  mark have special characteristics important for safety.  
 Furthermore, special parts which have purposes of fire-retardant (resistors), high-quality sound (capacitors), low-noise (resistors), etc. are used.  
 When replacing any of components, be sure to use only manufacturer's specified parts shown in the parts list.  
 \* The parenthesized in the Remarks columns specify the areas. (Refer to the cover page for area.)  
 Parts without these indication can be used for all areas.  
 \* Capacitor values are in microfarad ( $\mu$ F) unless specified otherwise, P=Pico-farads (pF) F=Farads (F)  
 \* Resistors values are in ohms, unless specified otherwise, 1k=1,000(OHM), 1M=1,000k(OHM)  
 \* [M] in Remarks column indicates parts that are supplied by MESA.

Ref No.	Part No.	Values & Remarks	Ref No.	Part No.	Values & Remarks	Ref No.	Part No.	Values & Remarks	Ref No.	Part No.	Values & Remarks
	<b>RESISTORS</b>		R144	ERDS2TJ222T	2.2K 1/4W [M]	R442	ERDS2TJ473T	47K 1/4W [M]	R523	ERDS2TJ392T	3.9K 1/4W [M]
			R145	ERDS2TJ102T	1K 1/4W [M]EB, E	R443	ERDS2TJ330T	33 1/4W [M]	R524	ERDS2TJ392T	3.9K 1/4W [M]
R103	ERDS2TJ101T	100 1/4W [M]	R145	ERDS2TJ561T	560 1/4W [M]EG	R451	ERDS2TJ224T	220K 1/4W [M]	R525	ERDS2TJ222T	2.2K 1/4W [M]
R104	ERDS2TJ102T	1K 1/4W [M]	R146	ERDS2TJ102T	1K 1/4W [M]EB, E	R452	ERDS2TJ224T	220K 1/4W [M]	R526	ERDS2TJ222T	2.2K 1/4W [M]
R105	ERDS2TJ471T	470 1/4W [M]	R146	ERDS2TJ561T	560 1/4W [M]EG	R453	ERDS2TJ391T	390 1/4W [M]	R527	ERDS2TJ122T	1.2K 1/4W [M]
R106	ERDS2TJ224T	220K 1/4W [M]	R147	ERDS2TJ474T	470K 1/4W [M]	R454	ERDS2TJ391T	390 1/4W [M]	R528	ERDS2TJ122T	1.2K 1/4W [M]
R107	ERDS2TJ471T	470 1/4W [M]	R148	ERDS2TJ474T	470K 1/4W [M]	R455	ERDS2TJ563T	56K 1/4W [M]	R529	ERDS2TJ273T	27K 1/4W [M]
R110	ERDS2TJ102T	1K 1/4W [M]	R149	ERDS2TJ680T	68 1/4W [M]	R456	ERDS2TJ563T	56K 1/4W [M]	R530	ERDS2TJ273T	27K 1/4W [M]
R112	ERDS2TJ104T	100K 1/4W [M]	R171	ERDS2TJ102T	1K 1/4W [M]	R457	ERDS2TJ271T	270 1/4W [M]	R531	ERDS2TJ332T	3.3K 1/4W [M]
R113	ERDS2TJ103T	10K 1/4W [M]	R172	ERDS2TJ102T	1K 1/4W [M]	R458	ERDS2TJ271T	270 1/4W [M]	R532	ERDS2TJ332T	3.3K 1/4W [M]
R114	ERDS2TJ562T	5.6K 1/4W [M]	R173	ERDS2TJ471T	470 1/4W [M]	R459	ERDS2TJ680T	68 1/4W [M]	R533	ERDS2TJ332T	3.3K 1/4W [M]
R115	ERDS2TJ561T	560 1/4W [M]	R175	ERDS2TJ102T	1K 1/4W [M]	R460	ERDS2TJ680T	68 1/4W [M]	R534	ERDS2TJ332T	3.3K 1/4W [M]
R116	ERDS2TJ102T	1K 1/4W [M]	R176	ERDS2TJ391T	390 1/4W [M]	R461	ERDS2TJ184T	180K 1/4W [M]	R543	ERDS2TJ102T	1K 1/4W [M]
R117	ERDS2TJ473T	47K 1/4W [M]	R181	ERDS2TJ332T	3.3K 1/4W [M]	R462	ERDS2TJ184T	180K 1/4W [M]	R544	ERDS2TJ102T	1K 1/4W [M]
R118	ERDS2TJ562T	5.6K 1/4W [M]	R401	ERDS2TJ102T	1K 1/4W [M]	R463	ERDS2TJ123T	12K 1/4W [M]	R545	ERDS2TJ824T	820K /4W [M]
R119	ERDS2TJ183T	18K 1/4W [M]	R402	ERDS2TJ102T	1K 1/4W [M]	R464	ERDS2TJ123T	12K 1/4W [M]	R546	ERDS2TJ332T	3.3K 1/4W [M]
R120	ERDS2TJ473T	47K 1/4W [M]	R405	ERDS2TJ102T	1K 1/4W [M]	R465	ERDS2TJ563T	56K 1/4W [M]	R601	ERDS2TJ221T	220 1/4W [M]
R121	ERDS2TJ332T	3.3K 1/4W [M]	R406	ERDS2TJ102T	1K 1/4W [M]	R466	ERDS2TJ563T	56K 1/4W [M]	R602	ERDS2TJ221T	220 1/4W [M]
R122	ERDS2TJ272T	2.7K 1/4W [M]	R407	ERDS2TJ102T	1K 1/4W [M]	R467	ERDS2TJ102T	1K 1/4W [M]	R603	ERDS2TJ563T	56K 1/4W [M]
R124	ERDS2TJ221T	220 1/4W [M]EG	R408	ERDS2TJ102T	1K 1/4W [M]	R468	ERDS2TJ102T	1K 1/4W [M]	R604	ERDS2TJ563T	56K 1/4W [M]
R124	ERDS2TJ271T	270 1/4W [M]EB, E	R411	ERDS2TJ102T	1K 1/4W [M]	R469	ERDS2TJ102T	1K 1/4W [M]	R605	ERDS2TJ182T	1.8K 1/4W [M]
R125	ERDS2TJ472T	4.7K 1/4W [M]	R412	ERDS2TJ102T	1K 1/4W [M]	R470	ERDS2TJ102T	1K 1/4W [M]	R606	ERDS2TJ182T	1.8K 1/4W [M]
R126	ERDS2TJ472T	4.7K 1/4W [M]	R413	ERDS2TJ102T	1K 1/4W [M]	R501	ERDS2TJ222T	2.2K 1/4W [M]	R607	ERDS2TJ563T	56K 1/4W [M]
R127	ERDS2TJ103T	10K 1/4W [M]	R414	ERDS2TJ102T	1K 1/4W [M]	R502	ERDS2TJ222T	2.2K 1/4W [M]	R608	ERDS2TJ563T	56K 1/4W [M]
R128	ERDS2TJ820T	82 1/4W [M]	R415	ERDS2TJ102T	1K 1/4W [M]	R503	ERDS2TJ103T	10K 1/4W [M]	R609	ERDS2TJ100T	10 1/4W [M]
R129	ERDS2TJ473T	47K 1/4W [M]	R416	ERDS2TJ102T	1K 1/4W [M]	R504	ERDS2TJ103T	10K 1/4W [M]	R610	ERDS2TJ100T	10 1/4W [M]
R130	ERDS2TJ102T	1K 1/4W [M]	R417	ERDS2TJ473T	47K 1/4W [M]	R508	ERDS1FVJ2R2 $\triangle$	2.2 1/2W [M]	R611	ERDS1FVJ100T $\triangle$	10 1/2W [M]
R131	ERDS2TJ102T	1K 1/4W [M]	R418	ERDS2TJ473T	47K 1/4W [M]	R511	ERDS2TJ471T	470 1/4W [M]	R612	ERDS1FVJ100T $\triangle$	10 1/2W [M]
R132	ERDS2TJ103T	10K 1/4W [M]	R419	ERDS2TJ104T	100K 1/4W [M]	R512	ERDS2TJ471T	470 1/4W [M]	R613	ERDS2TJ102T	1K 1/4W [M]
R133	ERDS2TJ102T	1K 1/4W [M]	R420	ERDS2TJ104T	100K 1/4W [M]	R513	ERDS2TJ474T	470K 1/4W [M]	R614	ERDS2TJ102T	1K 1/4W [M]
R134	ERDS2TJ102T	1K 1/4W [M]	R421	ERDS2TJ104T	100K 1/4W [M]	R514	ERDS2TJ474T	470K 1/4W [M]	R615	ERDS2TJ184T	180K 1/4W [M]
R135	ERDS2TJ102T	1K 1/4W [M]	R422	ERDS2TJ104T	100K 1/4W [M]	R515	ERDS2TJ474T	470K 1/4W [M]	R616	ERDS2TJ154T	150K 1/4W [M]
R136	ERDS2TJ102T	1K 1/4W [M]	R423	ERDS2TJ102T	1K 1/4W [M]	R516	ERDS2TJ474T	470K 1/4W [M]	R619	ERDS2TJ684T	680K 1/4W [M]
R137	ERDS2TJ102T	1K 1/4W [M]	R424	ERDS2TJ102T	1K 1/4W [M]	R517	ERDS2TJ821T	820 1/4W [M]	R620	ERDS2TJ473T	47K 1/4W [M]
R139	ERDS2TJ272T	2.7K 1/4W [M]	R425	ERDS2TJ103T	10K 1/4W [M]	R518	ERDS2TJ821T	820 1/4W [M]	R621	ERD25FVJ180T	18 1/4W [M]
R140	ERDS2TJ272T	2.7K 1/4W [M]	R426	ERDS2TJ103T	10K 1/4W [M]	R519	ERDS2TJ392T	3.9K 1/4W [M]	R622	ERD25FVJ180T	18 1/4W [M]
R141	ERDS2TJ102T	1K 1/4W [M]	R427	ERDS2TJ103T	10K 1/4W [M]	R520	ERDS2TJ392T	3.9K 1/4W [M]	R623	ERDS2TJ684T	680K 1/4W [M]
R142	ERDS2TJ102T	1K 1/4W [M]	R440	ERDS1FVJ820T $\triangle$	82 1/2W [M]	R521	ERDS2TJ223T	22K 1/4W [M]	R624	ERDS2TJ154T	150K 1/4W [M]
R143	ERDS2TJ222T	2.2K 1/4W [M]	R441	ERDS2TJ473T	47K 1/4W [M]	R522	ERDS2TJ223T	22K 1/4W [M]	R625	ERD2FCVJ470T	47 1/4W [M]

Ref No.	Part No.	Values & Remarks	Ref No.	Part No.	Values & Remarks	Ref No.	Part No.	Values & Remarks	Ref No.	Part No.	Values & Remarks
R626	ERDS2TJ473T	47K 1/4W [M]	R721	ERDS2TJ182T	1.8K 1/4W [M]	C132	ECBT1H102KB5	1000P 50V [M]	R951	ERDS2TJ122T	1.2K 1/4W [M]
R627	ERG1SJ101E 	100 1W [M]	R723	ERD2FCVJ4R7T	4.7 1/4W [M]	C133	ECBT1H150JC5	15P 50V [M]	R952	ERDS2TJ152T	1.5K 1/4W [M]
R628	ERG1SJ101E 	100 1W [M]	R724	ERDS2TJ122T	1.2K 1/4W [M]	C134	ECBT1H180JC5	18P 50V [M]	R953	ERDS2TJ182T	1.8K 1/4W [M]
R629	ERG1SJ101E 	100 1W [M]	R727	ERD25FVJ180T	18 1/4W [M]	C135	ECBT1C103MS5	0.01 16V [M]	R954	ERDS2TJ222T	2.2K 1/4W [M]
R630	ERG1SJ101E 	100 1W [M]	R728	ERD2FCVJ4R7T	4.7 1/4W [M]	C136	ECBT1C103MS5	0.01 16V [M]	R955	ERDS2TJ332T	3.3K 1/4W [M]
R631	ERDS2TJ223T	22K 1/4W [M]	R729	ERDS2TJ152T	1.5K 1/4W [M]	C137	ECBT1H561KB5	560P 50V [M]	R956	ERDS2TJ472T	4.7K 1/4W [M]
R633	ERDS2TJ103T	10K 1/4W [M]	R754	ERDS2TJ102T	1K 1/4W [M]	C138	ECBT1H561KB5	560P 50V [M]	R957	ERDS2TJ682T	6.8K 1/4W [M]
R635	ERDS2TJ102T	1K 1/4W [M]	R756	ERDS2TJ222T	2.2K 1/4W [M]	C139	ECQB1H682JM3	6800P 50V [M]	R960	ERDS2TJ102T	1K 1/4W [M]
R637	ERDS2TJ472T	4.7K 1/4W [M]	R772	ERDS2TJ104T	100K 1/4W [M]	C140	ECQB1H682JM3	6800P 50V [M]	R961	ERDS2TJ122T	1.2K 1/4W [M]
R639	ERDS2TJ474T	470K 1/4W [M]	R773	ERDS2TJ103T	10K 1/4W [M]	C141	ECEA1HKA010B	1 50V [M]	R962	ERDS2TJ152T	1.5K 1/4W [M]
R640	ERDS2TJ474T	470K 1/4W [M]	R774	ERDS2TJ223T	22K 1/4W [M]	C142	ECEA1HKA010B	1 50V [M]	R963	ERDS2TJ182T	1.8K 1/4W [M]
R641	ERDS2TJ221T	220 1/4W [M]	R775	ERDS2TJ332T	3.3K 1/4W [M]	C143	ECEA1HKA010B	1 50V [M]	R964	ERDS2TJ222T	2.2K 1/4W [M]
R642	ERDS2TJ221T	220 1/4W [M]	R777	ERDS2TJ220T	22 1/4W [M]	C144	ECEA1HKA010B	1 50V [M]	R970	ERDS2TJ102T	1K 1/4W [M]
R643	ERDS2TJ124T	120K 1/4W [M]	R778	ERDS2TJ222T	2.2K 1/4W [M]	C145	ECBT1H220JC5	22P 50V [M]	R971	ERDS2TJ122T	1.2K 1/4W [M]
R644	ERDS2TJ124T	120K 1/4W [M]	R779	ERDS2TJ103T	10K 1/4W [M]	C146	ECBT1H331KB5	330P 50V [M]	R972	ERDS2TJ152T	1.5K 1/4W [M]
R645	ERDS2TJ473T	47K 1/4W [M]	R780	ERDS2TJ473T	47K 1/4W [M]	C147	ECBT1H102KB5	1000P 50V [M]	R973	ERDS2TJ182T	1.8K 1/4W [M]
R646	ERDS2TJ274T	270K 1/4W [M]	R781	ERDS2TJ473T	47K 1/4W [M]	C148	ECBT1C103NS5	0.01 16V [M]	R974	ERDS2TJ222T	2.2K 1/4W [M]
R671	ERDS2TJ223T	22K 1/4W [M]	R782	ERDS2TJ153T	15K 1/4W [M]	C149	ECBT1C103NS5	0.01 16V [M]			
R672	ERDS2TJ223T	22K 1/4W [M]	R783	ERDS2TJ103T	10K 1/4W [M]	C150	ECBT1H104ZF5	0.1 50V [M]		<b>CAPACITORS</b>	
R675	ERDS2TJ682T	6.8K 1/4W [M]	R784	ERDS2TJ335T	3.3M 1/4W [M]	C172	ECBT1H331KB5	330P 50V [M]			
R681	ERDS2TJ270T	27 1/4W [M]	R901	ERDS2TJ102T	1K 1/4W [M]	C173	ECEA1CKA220B	22 16V [M]	C101	ECBT1C103NS5	0.01 16V [M]
R682	ERDS2TJ270T	27 1/4W [M]	R903	ERDS2TJ104T	100K 1/4W [M]	C174	ECEA1CKA101B	100 16V [M]	C103	ECBT1C103NS5	0.01 16V [M]
R683	ERDS2TJ270T	27 1/4W [M]	R906	ERDS2TJ393T	39K 1/4W [M]	C175	ECBT1C103NS5	0.01 16V [M]	C104	ECBT1H102KB5	1000P 50V [M]
R684	ERDS2TJ270T	27 1/4W [M]	R907	ERDS2TJ104T	100K 1/4W [M]	C176	ECBT1C103NS5	0.01 16V [M]	C105	ECBT1H470J5	47P 50V [M]
R685	ERDS2TJ270T	27 1/4W [M]	R908	ERDS2TJ104T	100K 1/4W [M]	C181	ECBT1H471KB5	470P 50V [M]	C106	ECBT1C103NS5	0.01 16V [M]
R686	ERDS2TJ270T	27 1/4W [M]	R909	ERDS2TJ104T	100K 1/4W [M]	C196	ECBT1H102KB5	1000P 50V [M]	C107	ECBT1H473ZF5	0.047 50V [M]
R687	ERDS2TJ270T	27 1/4W [M]	R910	ERDS2TJ102T	1K 1/4W [M]	C401	ECEA1VKA4R7B	4.7 35V [M]	C108	ECBT1H8R2KC5	8.2P 50V [M]
R688	ERDS2TJ270T	27 1/4W [M]	R911	ERDS2TJ104T	100K 1/4W [M]	C402	ECBT1E103ZF5	0.01 25V [M]	C109	ECBT1C103NS5	0.01 16V [M]
R689	ERDS2TJ270T	27 1/4W [M]	R917	ERDS2TJ103T	10K 1/4W [M]	C403	ECBT1E103ZF5	0.01 25V [M]	C110	ECBT1C103NS5	0.01 16V [M]
R690	ERDS2TJ223T	22K 1/4W [M]	R918	ERDS2TJ102T	1K 1/4W [M]	C404	ECEA1VKA4R7B	4.7 35V [M]	C111	ECEA1EKA4R7B	4.7 25V [M]
R690	ERDS2TJ270T	27 1/4W [M]	R919	ERDS2TJ102T	1K 1/4W [M]	C405	ECBT1H101KB5	100P 50V [M]	C112	ECBT1C103NS5	0.01 16V [M]
R691	ERDS2TJ270T	27 1/4W [M]	R920	ERDS2TJ271T	270 1/4W [M]	C406	ECBT1H102KB5	1000P 50V [M]	C113	ECBT1H102KB5	1000P 50V [M]
R692	ERDS2TJ270T	27 1/4W [M]	R921	ERDS2TJ121T	120 1/4W [M]	C409	ECA1CM220B	20 16V [M]	C114	ECEA1HKA3R3B	3.3 50V [M]
R693	ERDS2TJ270T	27 1/4W [M]	R922	ERDS2TJ472T	4.7K 1/4W [M]	C410	ECA1CM220B	20 16V [M]	C115	ECEA1EKA4R7B	4.7 25V [M]
R694	ERDS2TJ270T	27 1/4W [M]	R924	ERDS2TJ103T	10K 1/4W [M]	C411	ECBT1H101KB5	100P 50V [M]	C116	ECBT1C822MS5	8200P 16V [M]
R695	ERDS2TJ102T	1K 1/4W [M]	R925	ERDS2TJ103T	10K 1/4W [M]	C412	ECBT1H101KB5	100P 50V [M]	C117	ECQB1H471JM3	470P 50V [M]
R696	ERDS2TJ102T	1K 1/4W [M]	R927	ERDS2TJ181T	180 1/4W [M]	C413	ECA1CM100B	10 16V [M]	C118	ECQB1H103JM3	0.01 50V [M]
R699	ERDS2TJ332T	3.3K 1/4W [M]	R929	ERDS2TJ101T	100 1/4W [M]	C414	ECA1CM100B	10 16V [M]	C119	ECQB1H103JM3	0.01 50V [M]
R705	ERD2FCVJ4R7T	4.7 1/4W [M]	R930	ERDS2TJ101T	100 1/4W [M]	C415	ECBT1E103ZF5	0.01 25V [M]	C120	ECEA1HKA010B	1 50V [M]
R707	ERDS2TJ332T	3.3K 1/4W [M]	R941	ERDS2TJ472T	4.7K 1/4W [M]	C416	ECBT1E103ZF5	0.01 25V [M]	C121	ECEA1HKA010B	1 50V [M]
R708	ERDS2TJ102T	1K 1/4W [M]	R943	ERDS2TJ102T	1K 1/4W [M]	C417	ECBT1H101KB5	100P 50V [M]	C122	ECEA1HKA2R2B	2.2 50V [M]
R711	ERD25FVJ221T	220 1/4W [M]	R944	ERDS2TJ104T	100K 1/4W [M]	C418	ECBT1H101KB5	100P 50V [M]	C123	ECEA1HKA010B	1 50V [M]
R714	ERDS2TJ472T	4.7K 1/4W [M]	R945	ERDS2TJ104T	100K 1/4W [M]	C419	ECBT1H331KB5	330P 50V [M]	C124	ECBT1H102KB5	1000P 50V [M]
R715	ERDS2TJ1R5T	1.5 1/4W [M]	R946	ERDS2TJ103T	10K 1/4W [M]	C420	ECBT1H331KB5	330P 50V [M]	C125	ECBT1H150JC5	15P 50V [M]
R716	ERDS2TJ1R5T	1.5 1/4W [M]	R947	ERDS2TJ103T	10K 1/4W [M]	C421	ECBT1H331KB5	330P 50V [M]	C126	ECBT1H104ZF5	0.1 50V [M]
R717	ERDS2TJ752T	7.5K 1/4W [M]	R948	ERDS2TJ103T	10K 1/4W [M]	C422	ECBT1H331KB5	330P 50V [M]	C127	ECEA1CKA220B	22 16V [M]
R718	ERDS2TJ682T	6.8K 1/4W [M]	R949	ERDS2TJ103T	10K 1/4W [M]	C425	ECBT1H101KB5	100P 50V [M]	C128	ECBT1C103NS5	0.01 16V [M]
R719	ERD2FCVJ6R8T	6.8 1/4W [M]	R950	ERDS2TJ102T	1K 1/4W [M]	C426	ECBT1H101KB5	100P 50V [M]	C129	ECEA0JKA101B	100 6.3V [M]

Ref No.	Part No.	Values & Remarks	Ref No.	Part No.	Values & Remarks	Ref No.	Part No.	Values & Remarks	Ref No.	Part No.	Values & Remarks
C130	ECEAJKA101B	100 6.3V [M]	C530	ECQB1H273JM3	0.027 50V [M]	C712	ECA1HM470B	47 50V [M]			
C131	ECBT1C103NS5	0.01 16V [M]	C531	ECBT1E103ZF5	0.01 25V [M]	C713	ECKR1H103ZF5	0.01 50V [M]			
C427	ECBT1H221KB5	220P 50V [M]	C532	ECBT1E103ZF5	0.01 25V [M]	C716	ECEA2AU100B	10 100V [M]			
C428	ECBT1H221KB5	220P 50V [M]	C533	ECEA1CKA100B	10 16V [M]	C720	ECA1EM220B	22 25V [M]			
C431	ECA1CM100B	10 16V [M]	C534	ECEA1CKA100B	10 16V [M]	C722	ECQE2104KF3	0.1 250V [M]			
C432	ECA1CM100B	10 16V [M]	C536	ECBT1E103ZF5	0.01 25V [M]	C751	ECKWRS102MBC 	1000P 400V [M]			
C440	ECBT1E103ZF5	0.01 25V [M]	C601	ECEA1HN2R2SB	2.2 50V [M]	C752	ECKR1H103ZF5	0.01 50V [M]			
C451	ECEA1VKA4R7B	4.7 35V [M]	C602	ECEA1HN2R2SB	2.2 50V [M]	C753	ECA1EM102E 	1000 25V [M]			
C452	ECEA1VKA4R7B	4.7 35V [M]	C603	ECBT1H681KB5	680P 50V [M]	C756	ECBT1E103ZF5	0.01 25V [M]			
C453	CBT1H100JC5	10P 50V [M]	C604	ECBT1H681KB5	680P 50V [M]	C757	ECA1CM470B	70 16V [M]			
C454	ECBT1H100JC5	10P 50V [M]	C605	ECA1JM330B	33 6.3V [M]	C758	ECA1AM101B	100 10V [M]			
C455	ECBT1H102KB5	1000P 50V [M]	C606	ECA1JM330B	33 6.3V [M]	C759	ECA1EM220B	22 25V [M]			
C456	ECBT1H102KB5	1000P 50V [M]	C607	ECCR1H100K5	10P 50V [M]	C771	ECA1HM2R2B	2.2 50V [M]			
C457	ECEA1AU330B	33 10V [M]	C608	ECCR1H100K5	10P 50V [M]	C772	ECA1CM100B	10 16V [M]			
C458	ECEA1AU330B	33 10V [M]	C609	ECBT1H221KB5	220P 50V [M]	C773	ECBT1E223ZF5	0.022 25V [M]			
C459	ECFR1E223KR	0.022 25V [M]	C610	ECBT1H221KB5	220P 50V [M]	C774	ECEAJU221B	220 6.3V [M]			
C460	ECFR1E223KR	0.022 25V [M]	C611	ECQV1H473JZ3	0.047 50V [M]	C901	ECAJ0M102B	02 6.3V [M]			
C461	ECFR1E682KR	6800P 25V [M]	C612	ECQV1H473JZ3	0.047 50V [M]	C902	ECBT1H104ZF5	0.1 50V [M]			
C462	ECFR1E682KR	6800P 25V [M]	C613	ECBT1H681KB5	680P 50V [M]	C903	ECBT1E103ZF5	0.01 25V [M]			
C463	ECEA1VKA4R7B	4.7 35V [M]	C614	ECBT1H681KB5	680P 50V [M]	C904	ECAJ0M102B	02 6.3V [M]			
C464	ECEA1VKA4R7B	4.7 35V [M]	C615	ECEA2AN2R2SB	2.2 100V [M]	C905	ECBT1E103ZF5	0.01 25V [M]			
C465	ECBT1E103ZF5	0.01 25V [M]	C616	ECEA2AU100B	10 100V [M]	C906	ECEAJKA101B	100 6.3V [M]			
C466	ECBT1E103ZF5	0.01 25V [M]	C617	ECA1HM470B	47 50V [M]	C908	ECBT1E103ZF5	0.01 25V [M]			
C469	ECBT1H181KB5	180P 50V [M]	C618	ECEA2AU100B	10 100V [M]	C909	ECEA1VKA220B	22 35V [M]			
C470	ECBT1H181KB5	180P 50V [M]	C621	ECEA2AU100B	10 100V [M]	C910	ECEA1VKA220B	22 35V [M]			
C503	ECEAJKA101B	100 6.3V [M]	C623	ECKR1H223ZF5	0.022 50V [M]	C911	ECEA1VKA220B	22 35V [M]			
C504	ECEAJKA101B	100 6.3V [M]	C624	ECKR1H223ZF5	0.022 50V [M]	C912	ECEA1VKA220B	22 35V [M]			
C505	ECFR1C104MR	0.1 16V [M]	C625	ECEA1HN100SB	10 50V [M]	C913	ECEA1VKA100B	10 35V [M]			
C506	ECFR1C104MR	0.1 16V [M]	C626	ECEA1HN100SB	10 50V [M]	C914	ECEA1VKA100B	10 35V [M]			
C511	ECEA1HKA3R3B	3.3 50V [M]	C627	ECKR2H101KB5	100P 500V [M]	C916	ECEA1HKA010B	1 50V [M]			
C512	ECEA1HKA3R3B	3.3 50V [M]	C628	ECBT1H101KB5	100P 50V [M]	C917	ECAJ0M101B	01 6.3V [M]			
C513	ECBT1H150J5	15P 50V [M]	C629	ECBT1E223ZF5	0.022 25V [M]	C918	ECEAJKA101B	100 6.3V [M]			
C514	ECBT1H150J5	15P 50V [M]	C631	ECKR1H102KB5	1000P 50V [M]	C920	ECEA1HKA010B	1 50V [M]			
C515	ECBT1H221KB5	220P 50V [M]	C632	ECKR1H102KB5	1000P 50V [M]	C934	ECBT1H101KB5	100P 50V [M]			
C516	ECBT1H221KB5	220P 50V [M]	C683	ECBT1C332KR5	3300P 16V [M]	C937	ECBT1H101KB5	100P 50V [M]			
C517	ECBT1H330J5	33P 50V [M]	C684	ECBT1C332KR5	3300P 16V [M]	C943	ECBT1H331KB5	330P 50V [M]			
C518	ECBT1H330J5	33P 50V [M]	C685	ECBT1E103ZF5	0.01 25V [M]	C944	ECEA1CKA100B	10 16V [M]			
C519	ECEA1VKA4R7B	4.7 35V [M]	C701	ECBT1E103ZF5	0.01 25V [M]	C945	ECBT1E103ZF5	0.01 25V [M]			
C520	ECEA1VKA4R7B	4.7 35V [M]	C702	ECQE2104KF3	0.1 250V [M]	C946	ECBT1H470J5	47P 50V [M]			
C521	ECEA1VKA4R7B	4.7 35V [M]	C703	EC0S1JP472BB	4700P 63V [M]	C947	ECBT1H470J5	47P 50V [M]			
C522	ECEA1VKA4R7B	4.7 35V [M]	C704	EC0S1JP472BB	4700P 3V [M]	C948	ECBT1E103ZF5	0.01 25V [M]			
C523	ECFR1E123KR	0.012 25V [M]	C705	ECA1HM332E 	3300 50V [M]	C962	ECBT1H561KB5	560P 50V [M]			
C524	ECFR1E123KR	0.012 25V [M]	C706	ECA1HM332E 	3300 50V [M]	C963	ECBT1H102KB5	1000P 50V [M]			
C525	ECQV1H683JM3	0.068 50V [M]	C707	ECA1VM101B	100 35V [M]						
C526	ECQV1H683JM3	0.068 50V [M]	C708	ECKR1H103ZF5	0.01 50V [M]						
C527	ECBT1C562KR5	5600P 16V [M]	C709	ECA1CM330B	30 16V [M]						
C528	ECBT1C562KR5	5600P 16V [M]	C710	ECBT1E103ZF5	0.01 25V [M]						
C529	ECQB1H273JM3	0.027 50V [M]	C711	ECKR1H103ZF5	0.01 50V [M]						

## Packing Materials & Accessories

Notes : \* Important safety notice :  
 Components identified by  $\triangle$  mark have special characteristics important for safety.  
 Furthermore, special parts which have purposes of fire-retardant (resistors), high-quality sound (capacitors), low-noise (resistors), etc. are used.  
 When replacing any of components, be sure to use only manufacturer's specified parts shown in the parts list.

\* The parenthesized in the Remarks columns specify the areas. (Refer to the cover page for area.)  
 \* Parts without these indication can be used for all areas.  
 \* [M] in Remarks column indicates parts supplied by MESA.  
 \* The "(SF)" mark denotes the standard part.  
 \* Remote Control Unit : Supply period for three years from terminal of production.  
 \* Reference for O/I book languages are as follows :

Ar : Arabic	Cf : Canadian French	Ch : Chinese	Cz : Czech	Da : Danish
Du : Dutch	En : English	Fr : French	Ge : German	It : Italian
Ko : Korean	Po : Polish	Ru : Russian	Sp : Spanish	Sw : Swedish

Ref No.	Part No.	Part Name & Description	Remarks	Ref No.	Part No.	Part Name & Description	Remarks	Ref No.	Part No.	Part Name & Description	Remarks
		<b>PACKING MATERIALS</b>				<b>ACCESSORIES</b>		A5	RQT4382-D	O/I BOOK (Ge,It,Fr)	[M]EG
P1	SPSD152	ACCESSORY BOX	[M]	A1	EUR644858	REMOTE CONTROL	[M]	A5	RQT4383-R	O/I BOOK (Po,Cz,Ru)	[M]E
P2	RPG3890	PACKING CASE	[M]E	A1-1	UR64EC1987	R/C BATTERY COVER	[M]	A5	RQT4384-H	O/I BOOK (Da,Du)	[M]EG
P2	RPG3891	PACKING CASE	[M]EB EG	A2	RSA0010	LOOP ANT UNIT $\triangle$	[M]	A5	RQT4387-B	O/I BOOK R/C (En)	[M]EB
P3	RPN0865	POLYFOAM	[M]	A3	RJA0019-2K	AC CORD (SF) $\triangle$	[M]EG E	A5	RQT4388-E	O/I BOOK R/C (En,Sp,Sw)	[M]E
P4	RPF0005	MIRAMAT BAG	[M]	A3	RJA0053-1X	AC CORD (SF)	[M]EB	A5	RQT4389-D	O/I BOOK R/C (Ge,It,Fr)	[M]EG
P5	SPB1061	BAG	[M]	A4	RSA0007	FM ANTENA	[M]	A5	RQT4390-R	O/I BOOK R/C (Po,Cz,Ru)	[M]E
				A5	RQT4380-B	O/I BOOK (En)	[M]EB	A5	RQT4391-H	O/I BOOK R/C (Da,Du)	[M]EG
				A5	RQT4381-E	O/I BOOK (En,Sp,Sw)	[M]E	A6	SJP9009	ANT ADAPTER	[M]EB

## Packaging

### ACCESSORY

P1 (SPSD152)	: ACCESSORY BOX
A2 (RSA0010)	: LOOP ANT UNIT
A3 (RJA0019-2K)...E,EG	: AC CORD
A3 (RJA0053-1X)...EB	: AC CORD
A4 (RSA0007)	: FM ANTENA
A5 (RQT4380-B)...EB	: O/I BOOK
A5 (RQT4381-E)...E	: O/I BOOK
A5 (RQT4382-D)...EG	: O/I BOOK
A5 (RQT4383-R)...E	: O/I BOOK
A5 (RQT4384-H)...EG	: O/I BOOK
A5 (RQT4387-B)...EB	: O/I FOR R/C
A5 (RQT4388-E)...E	: O/I FOR R/C
A5 (RQT4389-D)...EG	: O/I FOR R/C
A5 (RQT4390-R)...E	: O/I FOR R/C
A5 (RQT4391-H)...EG	: O/I FOR R/C
A6 (SJP9009)...EB	: ANT ADAPTER

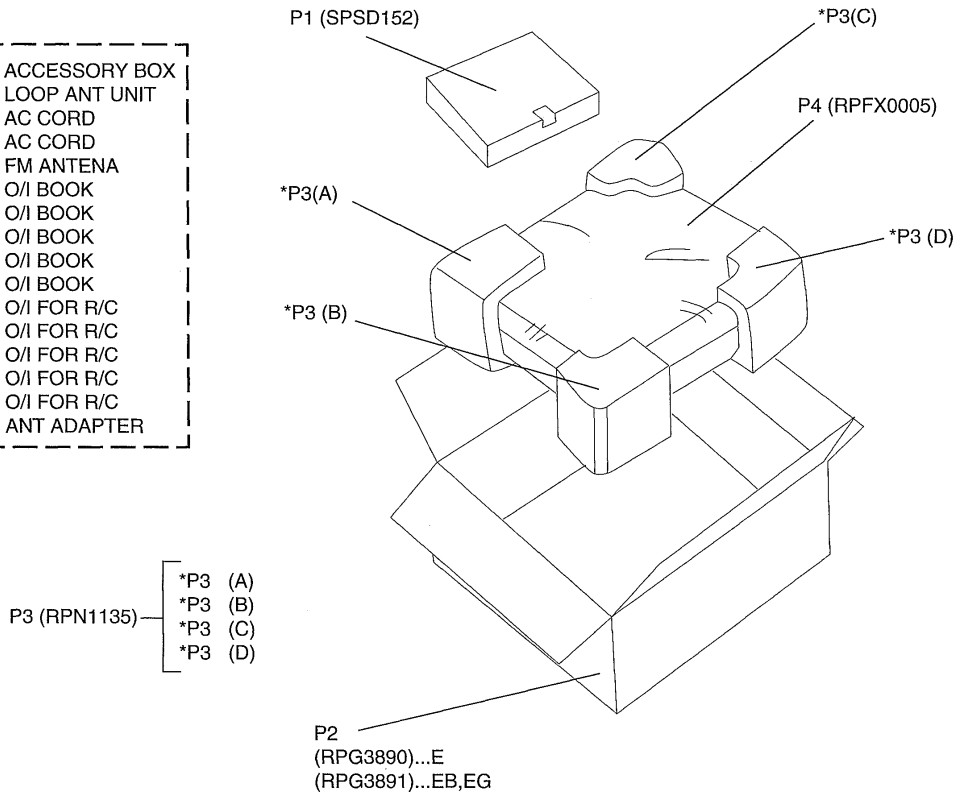

**MESA** Printed in Singapore  
 G980607200P/S/K/J  
 (FLE)